



Your easy way to space.



Space-Friendly™

CubeSat GPS Receiver/**Next Generation**
with **DROP** (Dead Reckoning Orbital Propagator)

piNAV-NG

Product Datasheet

Rev. A/2024

Intended to cover all **CubeSat Project** needs.

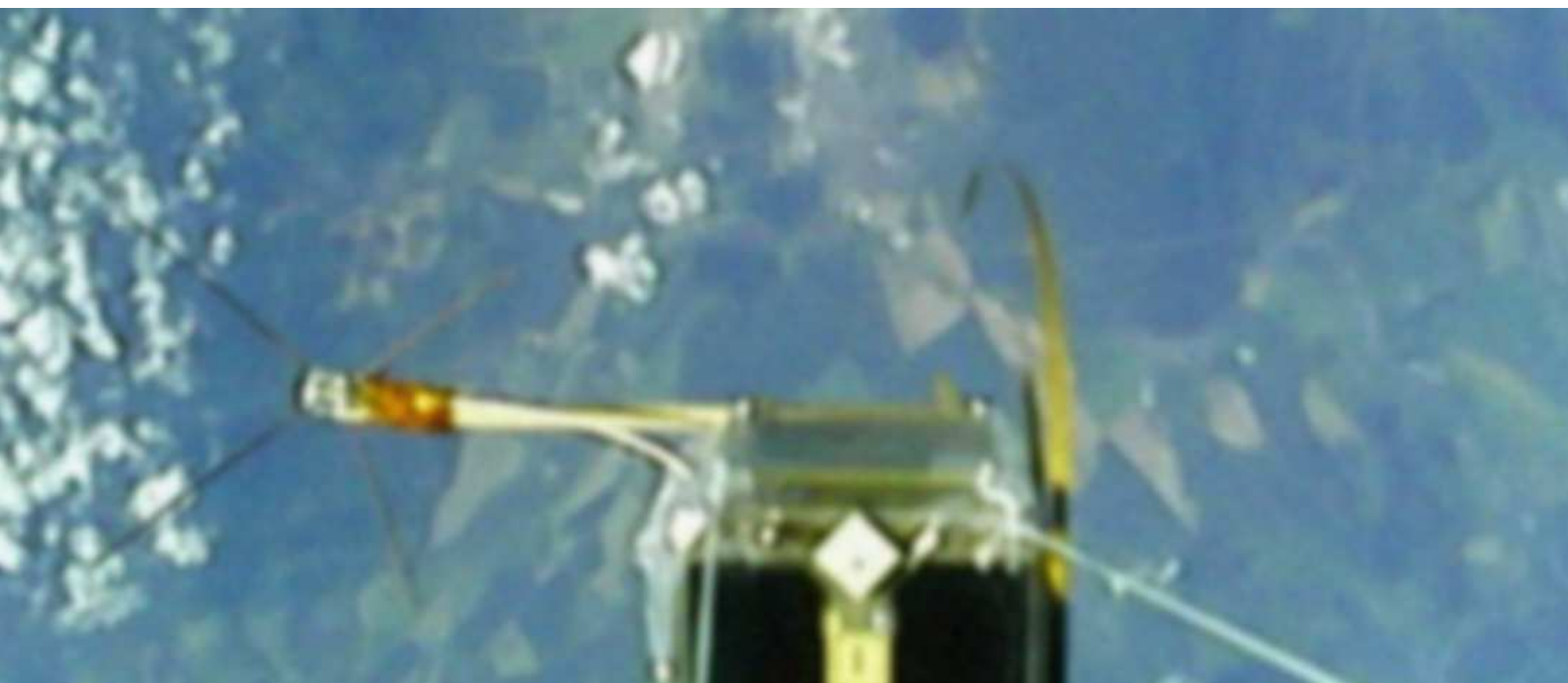

PRODUCT DATA SHEET

piNAV-NG

FEATURES

- **Fast Acquisition Unit for Cold Start (under 80 sec)**
- **Housekeeping Measurements Engine**
- **World's First Low Power CubeSat GPS Receiver with DROP (Dead Reckoning Orbital Propagator)**
- **Straightforward use – Plug-and-play device**
- **Allow Nonstop Operation with conventional 1U CubeSat power budget**
- **Power consumption**
125 mW (typical), 3.3 V @ 25°C
- **GPS L1 C/A signal, 15 channels**
- **Low Earth Orbit (LEO) operation**
Altitudes up to 3600 km
- **Velocity**
up to 9 km/s (Flight Model)
up to 0.5 km/s (Engineering Model)
- **Cold start time in LEO (Time-to-First Fix t_{TFF})**
80 seconds (typical)
- **Sensitivity**
Acquisition 38 dBc-Hz, Tracking 25 dBc-Hz
Short term fading 18 dBc-Hz
- **Protocols**
NMEA 0183 (standard GPS sentences)
piNAV (NMEA sentences extension)
- **Easy-to-Implement Data Interface**
UART 9600-8-N-1, 3V3-CMOS levels
- **Position update rate**
1 Hz
- **VPP (Valid Position Pulse) output**
(3V3-CMOS compatible)
- **PF (Position Fix) output**
(3V3-CMOS compatible)
- **2.7 to 3.6V power supply**
- **Active Antenna DC Bias Output (3.3V @ 50mA)**
- **Ultra Low Dimensions**
71.1×45.7×11 mm
- **Wide temperature range**
-40°C to +85°C
- **Connectors**
2 mm, 2×10 pin header (System Interface)
MCX (GPS Antenna Connector)
- **Supports Active or High Gain Passive GPS Antennas**
- **Ultra low mass 24 grams (incl. coating)**

APPLICATIONS

- **Position Measurement on Small Satellites**
- **CubeSats, PocketQube, Pico- Nano- Micro-Sats**
- **Limited Power Budget Space Projects**
- **Stratospheric, Meteorological, Scientific Balloons**
- **Precision Data Time-Stamping in Space**



Fig. 1 CubeSat GPS Receiver - Next Generation (piNAV-NG), Flight Model, Top side view.

GENERAL DESCRIPTION

The piNAV-NG is the Next Generation of Ultra Low Power Space-Friendly™ CubeSat GPS L1 receiver specially designed to provide continuous accurate position determination onboard small satellites in LEO or high altitude balloon missions with limited power and mass budgets.

It requires only 10 % of continuous power in comparison with conventional space-grade GPS receivers, allowing permanent data output with only a typical 1U CubeSat power budget.

Flight heritage optimized firmware uses the SkyFox Labs' proprietary DROP (Dead Reckoning Orbital Propagator) algorithm to compensate for orbital regions affected by terrestrial jammers penetrating to LEO regions causing GPS signal outage as well as for signal fading caused by improper antenna pointing or satellite tumbling without the need for uplink data.

The Engineering Model (EM) with the same mechanical and electrical properties is available with software limitation to maximum velocity (500 m/s). Red Remove Before Flight Finish is applied to prevent interchange with the Flight Model unit.

Evaluation Kit based on PC/104+ form factor PCB with USB-to-Serial cable, mechanical mount and system interface connector is available to accelerate FlatSat design and/or onboard software implementation during AIT/AIV activities.

TABLE OF CONTENTS

APPLICATIONS.....	2	OUTPUT DATA DESCRIPTION	7
GENERAL DESCRIPTION	2	DEAD RECKONING ORBITAL PROPAGATOR	10
TABLE OF CONTENTS	3	EXAMPLE LOW EARTH ORBIT DATA OUTPUT	12
ABSOLUTE MAXIMUM RATINGS	3	ENGINEERING MODEL	14
PARAMETRIC SPECIFICATION	3	TIMING DIAGRAM.....	15
CONNECTORS DESCRIPTION	4	EVALUATION KIT	15
FUNCTIONAL BLOCK DIAGRAM	5	APPLICATION NOTES & RECOMMENDATIONS.....	16
THEORY OF OPERATION.....	5	QUALITY ASSURANCE	16
ANTENNA.....	6	EXPORT CONTROL.....	17
PROTOCOLS.....	7	DISCLAIMER	18

ABSOLUTE MAXIMUM RATINGS

V_{DD} to GND.....	-0.3 V to +4.2 V	Other Pins to GND:.....	-0.3 V to +(V _{DD} +0.3) V
DC Input Voltage: V_I	-0.3 V to $V_{DD} + 0.3$ V (≤ 4.2 V max.)	Maximum RF Input Power:.....	+15 dBm
DC Output Voltage: V_O	-0.3 V to $V_{DD} + 0.3$ V (≤ 4.2 V max.)	Maximum Output Current to the Active Antenna:.....	100 mA
DC Input Current: I_I at $V_I < 0$ V or $V_I > V_{DD}$	± 20 mA	Operating Temperature Range:.....	-40°C to +85°C
DC Output Current: I_O at $V_O < 0$ V or $V_O > V_{DD}$	± 20 mA	Storage Temperature Range:.....	-55°C to +100°C

NOTE: Stresses beyond those listed under “Absolute Maximum Ratings” may cause permanent damage to the device. These are stress ratings only, and functional operation of the device at these or any other conditions beyond those indicated under specification conditions is not implied. Exposure to absolute maximum rated conditions for extended periods may affect device reliability. Voltage values are with respect to system ground terminal.

PARAMETRIC SPECIFICATION

$T_A = -40^\circ\text{C}$ to $+85^\circ\text{C}$, $V_{DD} = 3.3$ V, Active 35×35 mm GPS patch antenna with LNA preamplifier used, unless otherwise noted.

Parameter	Symbol	Min	Typ	Max	Units	Notes/Conditions
Operating Supply Voltage	V_{DD}	2.7	3.3	3.6	V	
Operating Supply Current	I_D		38	40	mA	Passive GPS Antenna is used.
				100		The inrush current of up to a maximum of 100 mA is drawn from the power supply for less than 1 second after power on.
Active Antenna Current Feed Capability	I_{Ant}	0		50	mA	Use of an active antenna is recommended for improving the C/N ₀ (SNR). However, the piNAV-NG can also be operated with passive antenna at zero feed current.
Operating Power Consumption with Passive GPS Antenna	$P_{Oper-Pass}$		125		mW	Passive GPS Antenna used.
Operating Power Consumption with Active GPS Antenna	$P_{Oper-Act}$			324	mW	Active GPS Antenna with LNA used. Value depending on antenna type.
				540		Input power drawn for less than 1 second after power on incl. active GPS antenna. Value depending on antenna type.
Reference Oscillator Stability			1	2.5	ppm	Over operating temperature range.
Acquisition Sensitivity	$P_{RF-IN-Acq}$		38		dBc-Hz	SNR required to acquire the GPS signal.
Elevation Mask Filter			3		°	Sats below the mask excluded from PVT.
Tracking Sensitivity	$P_{RF-IN-Trck}$	18	25		dBc-Hz	SNR to keep tracking the satellites in view.
PVT Calculation Filter			30		dBc-Hz	Sats below the level excluded from PVT.
Operating Frequency	f_{RFIN}		1575.42		MHz	GPS L1, C/A code.
Operating Bandwidth	BW		2		MHz	
Time-to-First-Fix	t_{TFF}		80		s	The piNAV-NG Cold Start time.
Warm Start Time	t_{WST}		50		s	The piNAV-NG DROP Warm Start time.
Valid Position Pulse Accuracy (2σ)	VPPA			1	μs	Time accuracy of the raising edge of the Valid Position Pulse (VPP). The GPS time of the rising edge of the VPP pulse is defined in following LSP and LSV navigation sentences.
Horizontal Position Accuracy (2σ)	HPA			10	m	No multipath signals (ionosphere and troposphere delay excluded), HDOP <3 caused by the noise and mutual acceleration of the LEO and GPS satellite ± 16 m/s ² .
Dynamic Stress Position Error	DSPE			2	m	Caused by the satellite movement in LEO orbit.
Operating Velocity	v	0		9	km/s	For Flight Model only. Otherwise maximum of 500 m/s.
Operating Altitudes	h			3600	Km	Above the WGS84. All orbit inclinations.
Operating Acceleration	a	0		5	g	
Velocity Calculation Accuracy (2σ)	VCE			0.1+1‰·v	m/s	

CONNECTORS DESCRIPTION

The piNAV-NG receiver is connected to the target system via the System Interface **Dual Row 2x10 pin** connector header (**2 mm pitch**). Each pin, its function and direction or manner of use is indicated in the Tab.: 1 below. The connector location within the Flight and Engineering Models is displayed in Fig. 2.

Tab.: 1 **The piNAV-NG Pin Description**, NOTE: Minimum required interface pins are highlighted.

Pin	Name	I/O, Power or Not Connected	Description
1	NC	NC	Not connected. Connect to GND.
2	VDD	Power	Positive system power input. Positive power supply input, connect to +3.3 V with respect to GND system ground pin.
3	NC	NC	Not connected. Connect to GND.
4	NC	NC	Not connected. Connect to GND.
5	/RESET	INPUT	Reset Input. Active in log. 0. No reset pulse needed. May be used to force Cold Start.
6	NC	NC	Not connected. Connect to GND.
7	NC	NC	Not connected. Connect to GND.
8	NC	NC	Not connected. Connect to GND.
9	NC	NC	Not connected. Connect to GND.
10	GND	Power	System ground. Must be connected to ground potential. This pin is internally connected (equal) to pin 13, 16 and 18.
11	TXD	OUTPUT	GPS Receiver Serial Data Output. NMEA and piNAV sentences are present on this pin. Data is provided by standard UART serial transfer at a rate of 9600 bps, no parity, 8 databits, 1 stop bit. New set of sentences are provided with update frequency of 1 Hz. LVCMOS compatible.
12	RXD	INPUT	GPS Receiver serial data input. Not used in normal operation. Data received on this pin has no effect. For future use. LVCMOS compatible.
13	GND	Power	System ground. Must be connected to ground potential. This pin is internally connected (equal) to pin 10, 16 and 18.
14	NC	NC	Not connected. Connect to GND.
15	NC	NC	Not connected. Connect to GND.
16	GND	Power	System ground. Must be connected to ground potential. This pin is internally connected (equal) to pin 10, 13 and 18.
17	PF	OUTPUT	Position Fix. This pin indicates the actual status of the piNAV-NG. Log. 0 indicates no GPS satellites are being tracked, no position data will be provided. Pulses with 0.5 Hz frequency (1000 ms log. 1, 1000 ms log. 0) indicates tracking of at least one GPS satellite, however no position data can be provided (not enough satellites). Permanent log. 1 indicates the piNAV-NG GPS position fix and provision of navigation data. Navigation data are valid and based on at least four GPS satellites in view.
18	GND	Power	System ground. Must be connected to ground potential. This pin is internally connected (equal) to pin 10, 13 and 16.
19	VPP	OUTPUT	Valid Position Pulse. Raising edge on this pin indicates time to which the position provided by the piNAV-NG was actual. This pin can be utilized for synchronization of the other satellite systems to the GPS or UTC time. LVCMOS compatible.
20	NC	NC	Not connected. Connect to GND.

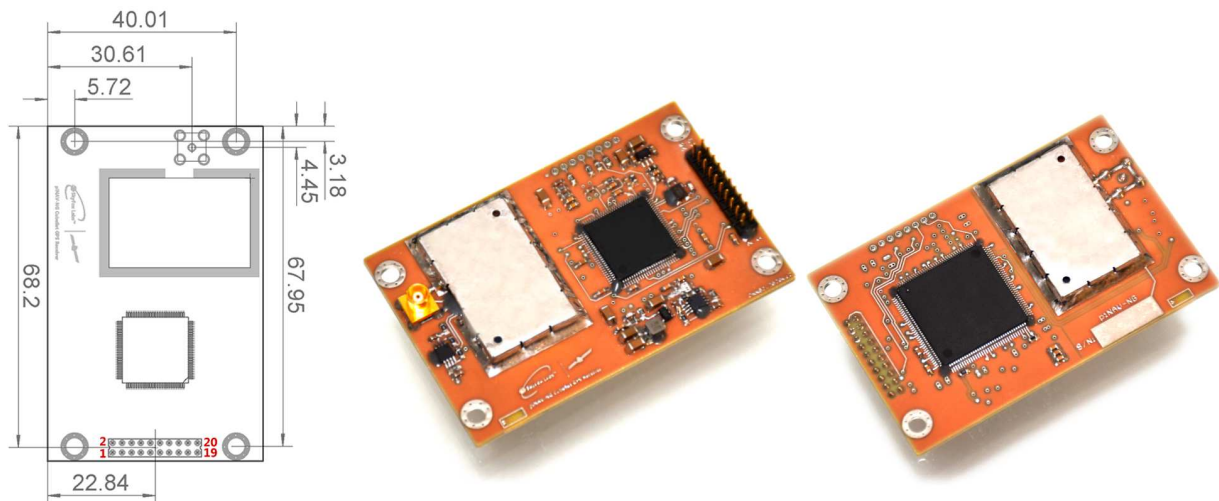

Fig. 2 **The piNAV-NG Dimensions, Connector pinout and device footprint (left), Top view (middle), Bottom view (right)**. NOTE: Dimensions are shown in millimeters. Detailed dimensions and STEP file available on request.

The piNAV-NG receiver is equipped with the **MCX-Female straight RF connector** (located on the module). The Right Angle MCX-Male connector is recommended to fit the standard CubeSat structure envelope.

FUNCTIONAL BLOCK DIAGRAM

The key functional blocks of the piNAV-NG are described in Fig. 3. The input block consists of the Low Noise Amplifier (LNA), SAW Filter, Down Converter and ADC. The design of the front-end guarantees excellent noise figure and ensure high suppression of the out of band signals. The digital IF signal on intermediate frequency 4092 kHz is processed by the array of 15 GPS L1 correlators (15 channels). The microcontroller demodulates, decodes and manages navigation messages, calculates position velocity and time (PVT), calculates Dilution of Precision (DOP) and satellite visibility, manages the satellite channels and generates NMEA and piNAV sentences. The messages are provided via serial UART. The piNAV-NG receiver is realized on 6-layers PCB including four power planes to maximally suppress the noise of analogue and digital circuits and protect the receiver circuits against interference from the other electronics (EMC susceptibility). High efficiency switching step-down regulator is used to produce the core voltage of 1.2 V for both computation cores. The GPS antenna as an external product can be operated as passive or active. The block diagram shows the phantom-like DC bias power supply feed of the active antenna.

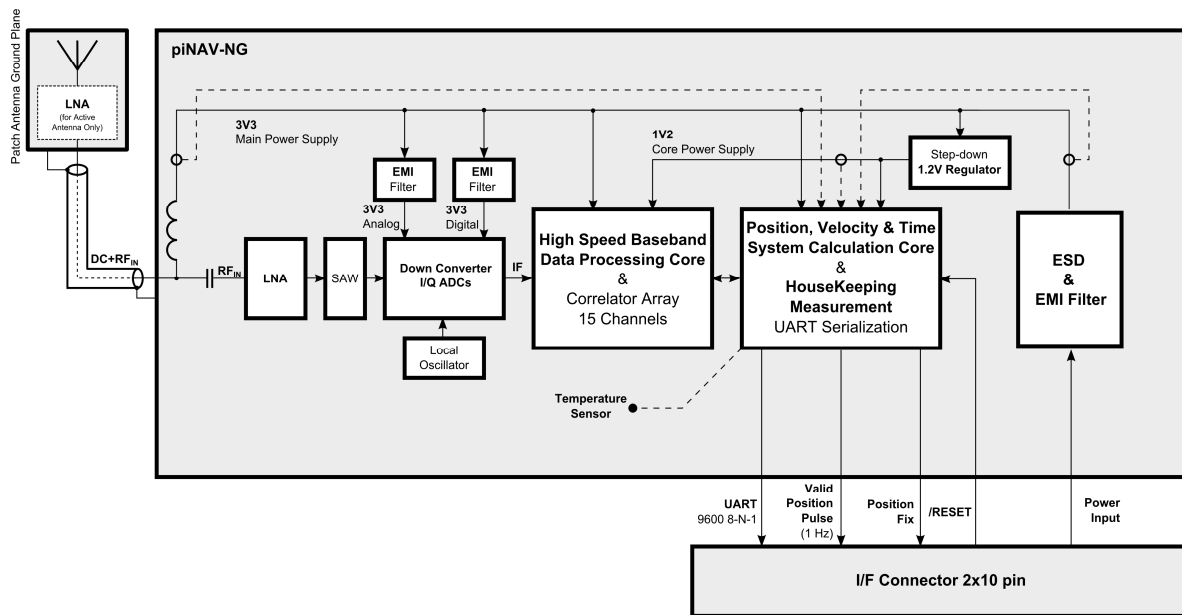

Fig. 3 The piNAV-NG Block Diagram.

THEORY OF OPERATION

The piNAV-NG receiver is a stand-alone 15-channels GPS L1 navigation receiver that uses navigation data (almanac and ephemeris) transmitted by the GPS navigation satellites for solving the navigation task and receiver management. No other external or augmentation data (uplink / upload) is needed or supported. The receiver is equipped with a software dead reckoning orbital propagator feature to cover signal (Fix) dropouts.

Minimal required signal-to-noise ratio (SNR) for reliable GPS satellite signal acquisition by the piNAV-NG receiver is 38 dBc-Hz. Once the satellite is acquired, the receiver accepts its lower SNR while keep it tracking. The receiver permanent tracking capability is then ensured if the SNR is higher than 25 dBc-Hz. The piNAV-NG tracking algorithm has been developed to be insensitive to the short (order of seconds) fading that may cause additional deterioration of the SNR as low as 18 dBc-Hz. The high tracking sensitivity feature provides excellent margin which could be efficiently exploited i.e. when the GPS signal reception is performed via side lobes of the antenna radiation pattern (i.e. when the satellite is slowly tumbling, etc.)

The firmware processes the acquired data, code and carrier phase measurement to calculate 3D position fix and velocity vector. The 2D position fix mode is not supported, since it is useless in LEO. The elevation mask of 3° and C/N₀ filter set to 30 dBc-Hz implemented in the Position, Velocity & Time algorithm (PVT) selects the GPS satellites used for position calculation. All the satellites below these limits are not included in position data processing in order to maximize the precision of the PVT data output.

The receiver channel management algorithm is programmed to seek for and to track all the satellites in view. If the position of the receiver is unknown (after power up), the elevation mask is not used. However, if the receiver does not process enough satellites above the elevation mask, but the number of the satellites including

satellite below elevation mask is enough for 3D position solution, the position information is provided with uncertainty. To increase the position information precision, the elevation mask is applied on calculated data in the following period. In this case the next NMEA sentences can be provided as empty as a result of elevation masking. Once the receiver acquires at least **four GPS satellites above the elevation mask** (3° or higher), the navigation information is provided continuously.

The PVT does not implement satellite geometry filter. However, its quality is measured by the DOP parameters and provided to the user in NMEA and piNAV sentences. The user can decide then, whether the relevant DOP parameter meets or exceeds the target application requirements (i.e. the conventional ADCS based on magnetometer requires only coarse position data for determination of the orientation of the magnetic flux vector thus even high DOPs can be considered as fully sufficient).

ANTENNA

The piNAV-NG receiver has been tested with various GPS antennas including passive and active (including/excluding local Low Noise Amplifier), helical, loop, GP and patch antennas to find the best setup providing maximum receiver performance, sensitivity and position fix capability onboard the CubeSat structure. The best results were observed with the patch antenna (35x35 mm) and local LNA (gain $P_{LNA} \geq +13$ dBm, noise figure NF approx. 1 dB) and Z-axis CubeSat panel serving as the Patch Antenna ground plane (copper PCB with square shape, outer dimensions 100x100 mm and milled corners fitting the standard CubeSat Structure Z-axis footprint). It is recommended to keep the antenna facing the Zenith with suitable ADCS (Attitude Determination and Control Subsystem). Recommended deviation from the Zenith allowing the piNAV-NG to fix the position within the t_{TFF} time is determined as a cone of $\pm 45^\circ$ along the Z-axis as described in Fig. 4 in order to face to at least four active (healthy) GPS satellites with a free line of sight above the Elevation Mask.



NOTE: *The blocking of the satellite reception by the target satellite construction or improper orientation of the antenna deteriorates the piNAV-NG receiver performance and prolongs the Time-to-First-Fix (t_{TFF}). The receiver disposes by sufficient tracking and acquisition margins and can be operated even if the part of the sky is blocked by the obstacle. However, the performance of the receiver cannot be guaranteed then. Note that the acquired satellite should be tracked at last 30 seconds with $C/N_0 > 38$ dBc-Hz to be able to receive ephemeris data and then the C/N_0 could not fall below 25 dBc-Hz permanently, otherwise the satellite tracking is not possible (typical Zenith GPS satellites are tracked on ground at approx. 43 to 48 dBc-Hz with Passive Antenna, at 48-55 dBc-Hz with Active Antenna).*

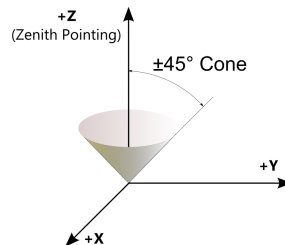

Fig. 4 The conical area borders of the vector perpendicular to recommended GPS patch antenna’s ground plane.

After the position fix the antenna can be swapped or rotated or periodically rotated in attitude to Nadir position and back to Zenith, whilst the tracking of the satellites is kept. However, when the signal to noise ratio C/N_0 of at least four visible GPS satellites fall below the 30 dBc-Hz level at the RF_{IN} input of the receiver, the position calculation will not be available to avoid providing with too inaccurate position data. When the C/N_0 of the latest four satellites serving for navigation reception falls below the minimum $P_{RF_IN-Trck}$ the receiver will be trying to maintain the tracking of the satellites while actively perform the seeking for the new satellites. The total loss of all satellite signals results in no position data output. To recover the position information output the receiver (without re-start) may take up to ~15 minutes, when the proper RF signal path is fully recovered (antenna looking towards the Zenith with no RF interference). **If the period with no PVT data is longer than ~20 minutes, the power re-cycle or Forced Reset is recommended to be performed externally, as it forces the receiver to work in Fast Acquisition Mode again, with TTF below 80 seconds again.** The 20 minute timeout may be shortened/prolonged by user to force the Fast Acquisition tracking algorithm whenever needed. The antenna/signal quality can be analysed by the SNR parameters in GSV navigation sentences. The SNR of the satellite signal with the active antenna in the place with clear view to the whole sky shall be at least 48 dBc-Hz for peak (Zenith) GPS satellites and at least 43 dBc-Hz for satellites with elevation higher than 30° .



CAUTION: *Because the central pin of the MCX coaxial connector is under DC bias when the piNAV-NG is powered on, the special care has to be taken when handling with the coaxial cable, connector and antenna as well. Never connect the GPS antenna element designed as a closed dipole antenna, closed loop antenna, closed helical type, etc. to the receiver input to **prevent the short circuit of the DC bias feed**. Keep in mind, the central tap of the conventional patch antenna is galvanically connected to the DC bias feed. Prevent the tap against short circuit with the ground plane or GND potential when the receiver is turned On. Short circuit of the DC bias feeding or its overloading over the Absolute maximum ratings may affect device reliability, damage the device and void the product warranty.*

Special care should be taken to the installation of the GPS receiver Antenna. The antenna shall be installed on the sufficiently large ground plane. The shape of the ground plane, near objects and antenna matching affects the patch resonant frequency and radiation pattern. SkyFox Labs™ as industry's first manufacturer is ready to offer tailored, optimized and flight-proven GPS antenna modules, fitting the all X/Y/Z sides of a standard CubeSat structures such as given in Fig. 5. since 2015.

For more details about the GNSS Antenna portfolio please visit: <http://www.skyfoxlabs.com>

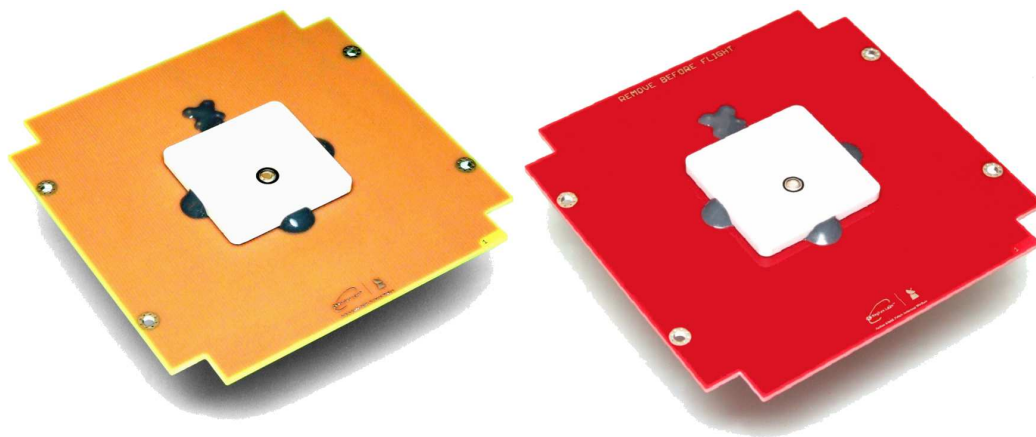

Fig. 5 The piPATCH-L1E1 GPS Patch Antenna – Flight Model (left), Engineering Model (right).

PROTOCOLS

The physical communication is realized via the standard UART data interface. The baud rate is set to 9600 bps, no parity, 8 data bits, 1 stop bit. Logical levels are equal to LVCMOS levels as defined in JEDEC JESD8C.01 standard.

The piNAV-NG receiver provides navigation data in standard NMEA 0183 format. The standard NMEA sentences GGA, GSA, GLL, RCM, VTG and GSV were augmented by the manufacturers's defined sentences (piNAV) LSP and LSV in the NMEA format. It provides position and velocity vector in the Cartesian coordinates in the reference frame WGS-84 and GPS time, including the UTC time compensated for system leap seconds.

As the receiver does not store the navigation data in the non-volatile memory, the UTC time in NMEA sentences is available after reception of the ionospheric and UTC data from the satellites. The coarse **GPS time** in piNAV sentences is available immediately after reception of any sub-frame with up to **~20 ms error**. The receiver time is corrected (**precised**) immediately after the position Fix (when the position of the satellite is known to compensate for the signal Time of Flight).

OUTPUT DATA DESCRIPTION

The NMEA navigation message (known as "sentence") is the ASCII characters string initiated with the "\$" and ended by CR+LF characters sequence. Each sentence is not longer than 80 characters.

The standard GPS receiver sentence is identified by characters "GP" immediately after the "\$" character. The type of the sentence is identified by the following three letters. The individual data fields are delimited by commas ",". The last optional field is a check sum introduced by the "*". The checksum is calculated as a logical XOR of all the bytes between the \$ and the * characters, written in ASCII representation of a hexadecimal number.

The initial set of **introductory data** is sent after each reset/power up. The **Engineering Model** output is:

* piNAV-NG v9.1 *
* PK (c) 2024 *
* Engineering Model *

The **Flight Model** initial data output is:

* piNAV-NG v9.1 *
* PK (c) 2024 *
* Flight Model *

Next, the receiver provides slightly modified GPS sentences **GGA, GSA, GLL, RCM, VTH** and **GSV**. Two new piNAV messages identified by the "PS" characters were defined. The first one, **LSP** (LEO Satellite Position), transfers user position into Cartesian coordinates in WGS-84 reference frame and GPS time of the position Fix. The second one, **LPV** (LEO Satellite Velocity), contains user velocity vector in Cartesian coordinates in WGS-84 reference frame and GPS time of the data (redundantly). The NMEA and piNAV sentences provided by the piNAV-NG receiver with detailed description and sample data are listed below:

GGA - Fix Data - The NMEA SENTENCE

\$GPGGA,172120.384,5219.0671,N,05117.0926,E,1,9,0.9,371262.1,M,0,M,,,*54

GGA Global Positioning System Fix Data
172120.384 Fix taken at 17:21:20.384 UTC
5219.0671,N Latitude 52 deg 19.0671' N
05117.0926,E Longitude 51 deg 17.0926' E
1 Fix quality: 0 = Invalid
1 = GPS Fix (Standard Positioning Service / SPS)
6 = DROP based Fix
9 Number of satellites being tracked
0.9 Horizontal Dilution of Precision (HDOP)
371262.1,M Altitude, meters, above WGS84 ellipsoid1
0,M Height of the Geoid (mean sea level) above WGS84 ellipsoid
(empty field) Time in seconds since last DGPS update
(empty field) DGPS station ID number
*54 The checksum data, always begin with *

GSA - GPS DOP and Active Satellites - The NMEA SENTENCE

\$GPGSA,M,3,31,32,22,24,19,11,17,14,20,,,,,1.6,0.9,1.3*3E

GSA Satellite status
M Auto selection of 2D or 3D fix (M = manual)
3 3D fix - values include: 1 = No GPS Fix (Dead Reckoning Orbital Propagator/
DROP based Fix position or no position)
2 = 2D GPS Fix (not implemented in piNAV-NG)
3 = 3D GPS Fix
31,32,... PRNs of satellites used for Fix (space for 12)
1.6 Position Dilution of Precision (PDOP)
0.9 Horizontal Dilution of Precision (HDOP)
1.3 Vertical Dilution of Precision (VDOP)
*3e The checksum data, always begin with *

1 NOTE: The original **MLS altitude** was replaced by the **Altitude above WGS84 ellipsoid**.

GLL – Geographic Latitude and Longitude - The NMEA SENTENCE

\$GPGLL, 5219.0671,N,05117.0926,E,172120.384,A,*10

GLL Geographic position, Latitude and Longitude
5219.0671,N Latitude 52 deg. 19.0671 min. North
05117.0926,E Longitude 51 deg. 17.0926 min. East
172120.384 Fix taken at 17:21:20.384 UTC
A A = Autonomous (3D GPS Fix), E = Estimated (DROP based Fix), N = Data NOT valid
***10** The checksum data, always begin with *

RMC – Recommended Minimum Data - The NMEA SENTENCE

\$GPRMC, 172120.384,A,5219.0671,N,05117.0926,E,14465.87,60.58,230630,,,*15

RMC Recommended Minimum sentence C
172120.384 Fix taken at 17:21:20.386 UTC
A A = Autonomous (3D GPS Fix), E = Estimated (DROP based Fix), N = Data NOT valid
5219.0671,N Latitude 52 deg 19.0671' N
05117.0926,E Longitude 51 deg 17.0926' E
14465.87 Speed over the ground in knots
60.58 Track angle in degrees true
230630 Date
, Magnetic Variation²
***15** The checksum data, always begin with *

VTG – Vector track and Speed over the Ground - The NMEA SENTENCE

\$GPVTG, 60.58,T,,M,14465.87,N,26790.86,K,A,*23

VTG Track made good and ground speed
60.58,T True track made good (degrees)
,M Magnetic track made good³
14465.87,N Ground speed, knots
26790.86,K Ground speed, kilometres per hour
A A = Autonomous (3D GPS Fix), E = Estimated (DROP based Fix), N = Data NOT valid
***23** The checksum data, always begin with *

GSV – Satellites in View – The NMEA SENTENCE

\$GPGSV, 4, 1, 15, 31, 23, 152, 51, 32, 46, 279, 52, 12, 2, 50, 00, 22, 26, 96, 51*4A

GSV Satellites in view
4 Number of sentences for full data
1 Sentence 1 of 4
15 Number of satellites in view
31 Satellite PRN number
23 Elevation, degrees
152 Azimuth, degrees
51 Carrier to Noise Ratio (C/N0), for up to 4 satellites per sentence
 PRN number, elevation, azimuth and C/N0 is repeated four times in total.
***4A** The checksum data, always begin with *

The number of satellite in view is always 15 as the receiver has 15 channels. The PRN, Elevation, and Azimuth are assigned to the channels that process the satellites above the horizon otherwise the empty entry is transmitted. The tracked satellites have non-zero C/N0.

² NOTE: **Magnetic variation** is not supported.

³ NOTE: **Magnetic track made good** is not supported.

LSP – LEO Satellite Position – The piNAV SENTENCE

\$PSLSP, 193772.0585851, 780, 3963889.204, 1001383.917, 4879428.991, 5, 4.5*72

LSP	LEO satellite position
193772.0585851	GPS time [s] to which the rising edge of the Valid Position Pulse (VPP) was calculated
780	GPS week
3963889.204	X position referenced to WGS-84 [m]
1001383.917	Y position referenced to WGS-84 [m]
4879428.991	Z position referenced to WGS-84 [m]
5	Number of satellites used for PVT
4.5	Position Dilution of Precision (PDOP)
*72	The checksum data, always begin with *

LSV – LEO Satellite Velocity – The piNAV SENTENCE

\$PSLSV, 193772.0585851, 780, 0.051, 0.017, 0.034, 5, 4.5*7B

LSV	LEO satellite velocity
193772.0585851	GPS time [s] to which the rising edge of the Valid Position Pulse (VPP) was calculated
780	GPS week
0.051	v_x velocity referenced to WGS-84 [m/s]
0.017	v_y velocity referenced to WGS-84 [m/s]
0.034	v_z velocity referenced to WGS-84 [m/s]
5	Number of satellites used for PVT
4.5	Position Dilution of Precision (PDOP)
*7B	The checksum data, always begin with *

LSS – LEO Satellite Status – The piNAV SENTENCE

\$PSLSS, 3.30, 1.20, 3.29, 45, 9, 22*7B

LSS	LEO satellite status
3.30	Main Input Bus voltage in Volts
1.20	1.2V Core Voltage in Volts
3.29	3.3V Core Voltage in Volts
45	Main Total Input Current in miliAmps
9	Output Current fed to the Active Antenna port in miliAmps
22	Core temperature in deg Celsius. Negative temperature with –sign (e.g. “-7”)
*7B	The checksum data, always begin with *

DEAD RECKONING ORBITAL PROPAGATOR

The piNAV-NG firmware is build around the key principle of processing an extremely weak RF signal directly from the GPS constellation satellites. In case the antenna of the GPS receiver system is **unable to pick up a proper signal quality, signal strength** or locally (in-situ) the **signal is jammed** from (unfortunately) increasing amount of terrestrial sources powerful enough to penetrate up to the LEO altitudes, making high areas of orbits without usable GPS signal, the **Dead Reckoning Orbital Propagator** (or **DROP**) algorithm serves as a mathematical solution implemented in the piNAV-NG firmware to overcome the GPS PVT/Fix dropouts.

During the GPS position Fix, the DROP algorithm continuously integrates the data measured and improves the estimation of the satellite state vector by an infinite impulse response **Hatch filter** with a maximal time constant of **100 seconds**. The filter is initiated by the first Fix obtained after power up (Cold Start) and is continuously loaded up to 100 seconds of Fix data, during the flight. Once the GPS Fix is not available for a reasons such as: incorrect antenna attitude, in-situ GPS signal jamming, not enough GPS Satellites in View, less than 4 healthy satellites above the elevation mask or less than 30 dBc-Hz in at least 4 healthy sats SNRs, etc., the PVT output is estimated and provided by the mathematical principle using DROP algorithm.

The DROP algorithm position output is provided based on the last set(s) of valid position(s) and velocity(ies) vectors information by the numerical solution of the satellite motion equations, which considers only a gravitation field of the Earth's mass center. No other phenomenon, like satellite slowed down by the residuals of the atmosphere (atmospheric drag), influence of the non-uniform distribution of the mass in Earth's body (non uniform Earth's gravitational field), as well as the solar wind, is not considered. The propagated PVT data output precision thus depends on the quality of the last valid GPS Fix(es) and satellite orbit. A typical 3D precision error is in the order of **~6 000 meters per 15 minutes** in LEO and fully loaded DROP filter Fix dataset. An example of the error DROP algorithm error based on RF signal simulator output is given in Fig. 6 and .

The receiver position provided by DROP propagator is coded to the NMEA sentences in a standard way. The type of position data is indicated by a position status flag in GLL, RMC, and VTG messages and by a 123 mode flag in GGA; see OUTPUT DATA DESCRIPTION paragraphs.



NOTE: The implemented Dead Reckoning Orbital Propagator algorithm can predict only LEO (altitudes up to 3600 km above the sea level) satellite trajectory (standard orbital velocity movement) in the gravitation field of the Earth **without** artificial acceleration forces such as powered flight (with active propulsion), once it loses the nominal GPS constellation Fix. For other trajectories, such as propulsion-driven orbital parameters modification (powered flight with thrusters activated), do not provide relevant data and may act as a predictor of a ballistic freefall towards the gravitational center of the Earth or its escape. Moreover, the algorithm does **not implement nor utilize the Luni-Solar acceleration coefficients or gravity fields influence of other celestial bodies** in the PVT calculation output as they are not available in the GPS system transmission. Those, if known, may offer improved precision of the position and velocity prediction. The **propagator is activated** if the magnitude of the **velocity vector** is between **7000 - 9000 m/s**.

Another DROP algorithm benefit for the piNAV-NG GPS receiver system functionality is the fact that the firmware is able to implement the Warm Start (PVT Fix recovery based on available RF signal data from the GPS constellation) much faster than in case where all satellite channels tracking were lost/dropped such as during the Cold Start. The DROP estimated position is precise more than enough even after **15-30 minutes** with no proper Fix to get the receiver an accurate information about the GPS satellite for the search and track (re-acquisition) algorithm. Typical **Warm Start time** is in order of **50 seconds**.

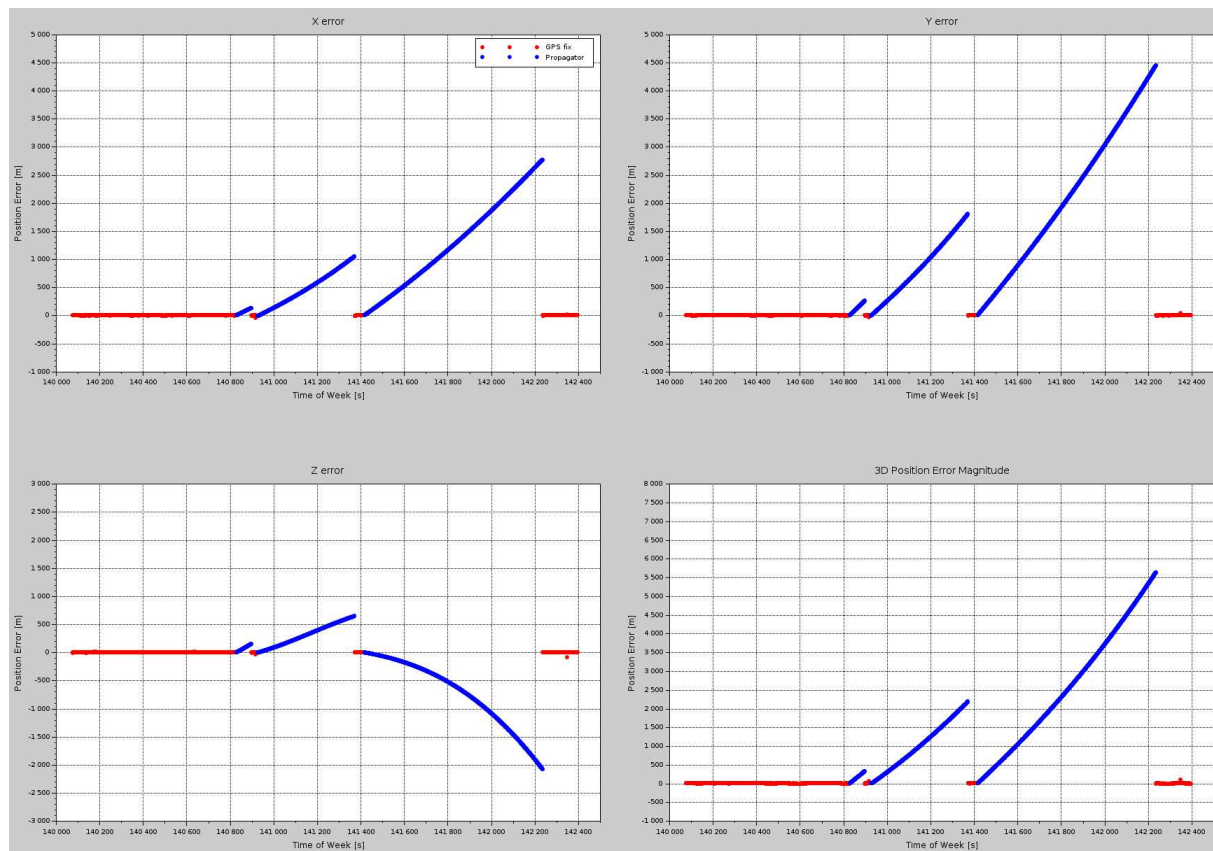

Fig. 6 DROP algorithm output data precision (error) based on RF Signal Simulator during LEO velocity flight.

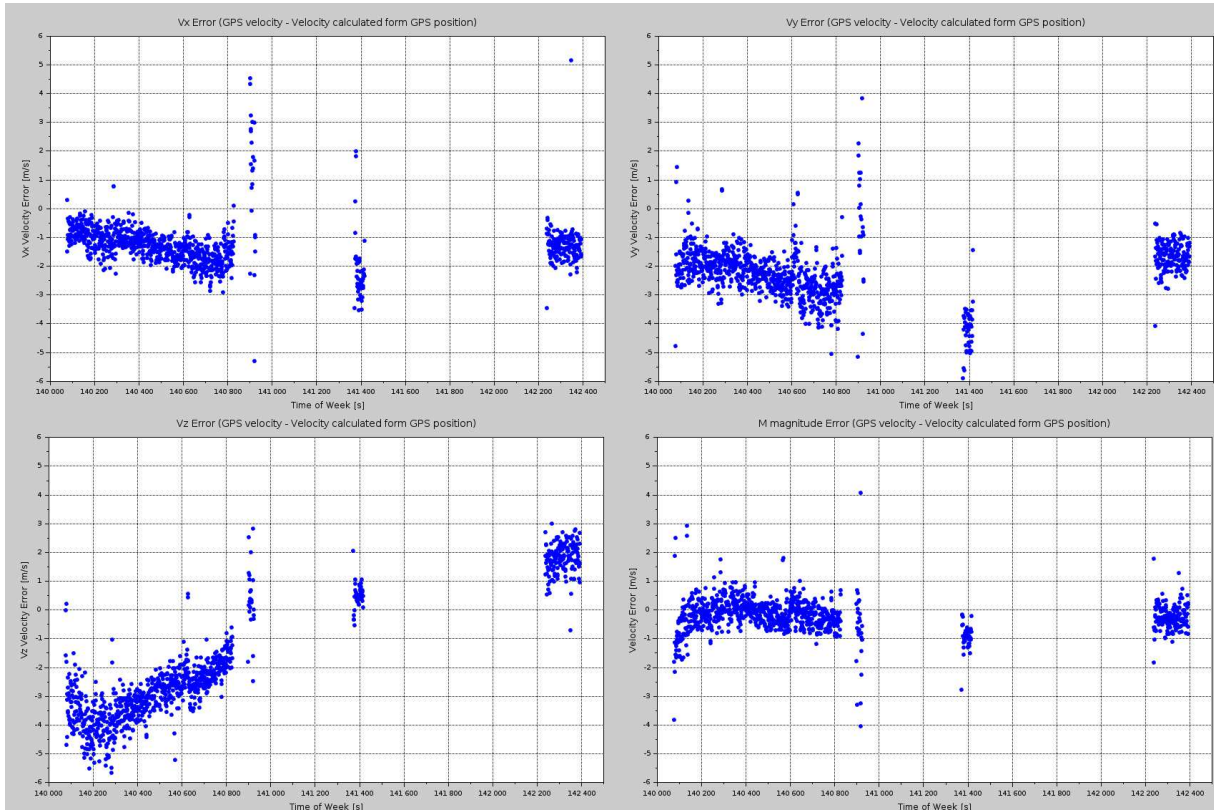

Fig. 7 Velocity data output precision (error) based on RF Signal Simulator during LEO velocity flight.



NOTE: Orbital propagator alternatives such as SGP-4 would be considered much more accurate, however for its proper functionality it either requires the initial TLE uplink or much more Fix data to be collected over several orbits (several hours of continual GPS operations), which may not be an easily fulfilled requirement (satellite OBC restarts, power cycling, South Atlantic Anomaly or Single Event Effects induced bitflips or restarts, power savings with GPS receiver OFF, etc.). The onboard ADCS software however still can implement algorithms such as SGP-4 and work with valid GPS fixes only for maximum orbital determination precision, if needed.

EXAMPLE LOW EARTH ORBIT DATA OUTPUT

```

$PSLSP,3057.1000808,801,-6608089.658,114889.086,-1699233.376,7,2.6*42
$PSLSV,3057.1000808,801,1390.621,-4425.955,-5644.129,7,2.6*4B
$PSLSS,3.30,1.20,3.29,45,9,22*7B
$GPGGA,005047.100,1430.3431,S,17900.2369,E,1,7,1.4,447228.9,M,0,M,,,*42
$GPGSA,M,3,12,21,18,15,25,05,09,,,,,2.6,1.4,2.1*3A
$GPGLL,1430.3431,S,17900.2369,E,005047.100,A,*00
$GPRMC,005047.100,A,1430.3431,S,17900.2369,E,14201.88,142.96,281214,,,,*35
$GPVTG,142.96,T,,M,14201.88,N,26301.95,K,A,*15
$GPGSV,4,1,15,12,54,57,45,21,41,284,45,27,5,13,00,18,20,346,45*49
$GPGSV,4,2,15,15,8,31,45,30,8,233,00,02,6,139,00,25,71,185,45*7E
$GPGSV,4,3,15,05,29,122,45,,,,,09,12,5,45,,,,*7A
$GPGSV,4,4,15,,,,,,,*7D
$PSLSP,3058.1000861,801,-6606687.182,110462.244,-1704875.690,7,2.6*45
$PSLSV,3058.1000861,801,1398.229,-4426.302,-5641.995,7,2.6*4E
$PSLSS,3.30,1.20,3.29,45,9,22*7B
$GPGGA,005048.100,1433.2976,S,17902.5270,E,1,7,1.4,447214.0,M,0,M,,,*4B
$GPGSA,M,3,12,21,18,15,25,05,09,,,,,2.6,1.4,2.1*3A
$GPGLL,1433.2976,S,17902.5270,E,005048.100,A,*0F
$GPRMC,005048.100,A,1433.2976,S,17902.5270,E,14201.91,142.95,281214,,,,*31
    
```

\$GPVTG,142.95,T,,M,14201.91,N,26302.00,K,A,*11
\$GPGSV,4,1,15,12,54,57,45,21,41,284,45,27,5,13,00,18,20,346,45*49
\$GPGSV,4,2,15,15,8,31,45,30,8,233,00,02,6,139,00,25,71,185,45*7E
\$GPGSV,4,3,15,05,29,122,45,,,,,09,12,5,45,,,,*7A
\$GPGSV,4,4,15,,,,,,,*7D
\$PSLSP,3059.1000914,801,-6605273.689,106037.503,-1710516.527,7,2.6*42
\$PSLSV,3059.1000914,801,1405.836,-4426.646,-5639.861,7,2.6*4B
\$PSLSS,3.30,1.20,3.29,45,9,22*7B
\$GPGGA,005049.100,1436.2524,S,17904.8170,E,1,7,1.4,447196.0,M,0,M,,,*45
\$GPGSA,M,3,12,21,18,15,25,05,09,,,,,2.6,1.4,2.1*3A
\$GPGLL,1436.2524,S,17904.8170,E,005049.100,A,*08
\$GPRMC,005049.100,A,1436.2524,S,17904.8170,E,14201.95,142.94,281214,,,*33
\$GPVTG,142.94,T,,M,14201.95,N,26302.07,K,A,*13
\$GPGSV,4,1,15,12,54,57,45,21,41,284,45,27,5,13,00,18,20,346,45*49
\$GPGSV,4,2,15,15,8,31,45,30,8,233,00,02,6,139,00,25,71,185,45*7E
\$GPGSV,4,3,15,05,29,122,45,,,,,09,12,5,45,,,,*7A
\$GPGSV,4,4,15,,,,,,,*7D
\$PSLSP,3060.1000967,801,-6603856.773,101612.586,-1716154.900,7,2.6*45
\$PSLSV,3060.1000967,801,1413.434,-4426.983,-5637.711,7,2.6*4C
\$PSLSS,3.30,1.20,3.29,45,9,22*7B
\$GPGGA,005050.100,1439.2060,S,17907.1080,E,1,7,1.4,447181.9,M,0,M,,,*4C
\$GPGSA,M,3,12,21,18,15,25,05,09,,,,,2.6,1.4,2.1*3A
\$GPGLL,1439.2060,S,17907.1080,E,005050.100,A,*0E
\$GPRMC,005050.100,A,1439.2060,S,17907.1080,E,14201.97,142.92,281214,,,*31
\$GPVTG,142.92,T,,M,14201.97,N,26302.11,K,A,*10
\$GPGSV,4,1,15,12,54,57,45,21,41,284,45,27,5,13,00,18,20,346,45*49
\$GPGSV,4,2,15,15,8,31,45,30,8,233,00,02,6,139,00,25,71,185,45*7E
\$GPGSV,4,3,15,05,29,122,45,,,,,09,12,5,45,,,,*7A
\$GPGSV,4,4,15,,,,,,,*7D
\$PSLSP,3061.1001020,801,-6602427.515,97187.285,-1721790.821,7,2.6*7F
\$PSLSV,3061.1001020,801,1421.040,-4427.321,-5635.561,7,2.6*44
\$PSLSS,3.30,1.20,3.29,45,9,22*7B
\$GPGGA,005051.100,1442.1597,S,17909.4002,E,1,7,1.4,447163.0,M,0,M,,,*4B
\$GPGSA,M,3,12,21,18,15,25,05,09,,,,,2.6,1.4,2.1*3A
\$GPGLL,1442.1597,S,17909.4002,E,005051.100,A,*0C
\$GPRMC,005051.100,A,1442.1597,S,17909.4002,E,14202.01,142.91,281214,,,*3C
\$GPVTG,142.91,T,,M,14202.01,N,26302.19,K,A,*17
\$GPGSV,4,1,15,12,54,57,45,21,41,284,45,27,5,13,00,18,20,346,45*49
\$GPGSV,4,2,15,15,8,31,45,30,8,233,00,02,6,139,00,25,72,186,45*7E
\$GPGSV,4,3,15,05,29,122,45,,,,,09,12,5,45,,,,*7A
\$GPGSV,4,4,15,,,,,,,*7D
\$PSLSP,3062.1001073,801,-6600992.062,92761.510,-1727424.311,7,2.6*7C
\$PSLSV,3062.1001073,801,1428.650,-4427.649,-5633.406,7,2.6*42
\$PSLSS,3.30,1.20,3.29,45,9,22*7B
\$GPGGA,005052.100,1445.1125,S,17911.6936,E,1,7,1.4,447145.5,M,0,M,,,*46
\$GPGSA,M,3,12,21,18,15,25,05,09,,,,,2.6,1.4,2.1*3A
\$GPGLL,1445.1125,S,17911.6936,E,005052.100,A,*00
\$GPRMC,005052.100,A,1445.1125,S,17911.6936,E,14202.05,142.90,281214,,,*35
\$GPVTG,142.90,T,,M,14202.05,N,26302.26,K,A,*1E
\$GPGSV,4,1,15,12,54,57,45,21,41,284,45,27,5,13,00,18,20,346,45*49
\$GPGSV,4,2,15,15,8,31,45,30,8,233,00,02,6,139,00,25,72,186,45*7E
\$GPGSV,4,3,15,05,29,122,45,,,,,09,12,5,45,,,,*7A
\$GPGSV,4,4,15,,,,,,,*7D
\$PSLSP,3063.1001126,801,-6599548.561,88334.587,-1733055.965,7,2.6*7D
\$PSLSV,3063.1001126,801,1436.240,-4427.975,-5631.234,7,2.6*4D
\$PSLSS,3.30,1.20,3.29,45,9,22*7B
\$GPGGA,005053.100,1448.0652,S,17913.9886,E,1,7,1.4,447127.5,M,0,M,,,*4F
\$GPGSA,M,3,12,21,18,15,25,05,09,,,,,2.6,1.4,2.1*3A
\$GPGLL,1448.0652,S,17913.9886,E,005053.100,A,*0D
\$GPRMC,005053.100,A,1448.0652,S,17913.9886,E,14202.07,142.89,281214,,,*32
\$GPVTG,142.89,T,,M,14202.07,N,26302.30,K,A,*13

```

$GPGSV,4,1,15,12,54,56,45,21,41,284,45,27,5,13,00,18,20,346,45*48
$GPGSV,4,2,15,15,8,31,45,30,8,233,00,02,6,139,00,25,72,186,45*7E
$GPGSV,4,3,15,05,29,122,45,,,,,09,12,5,45,,,,*7A
$GPGSV,4,4,15,,,,,,,*7D
$PSLSP,3064.1001179,801,-6598102.186,83906.071,-1738684.111,7,2.6*70
$PSLSV,3064.1001179,801,1443.847,-4428.295,-5629.064,7,2.6*4B
$PSLSS,3.30,1.20,3.29,45,9,22*7B
$GPGGA,005054.100,1451.0161,S,17916.2855,E,1,7,1.4,447113.6,M,0,M,,, *43
$GPGSA,M,3,12,21,18,15,25,05,09,,,,,2.6,1.4,2.1*3A
$GPGLL,1451.0161,S,17916.2855,E,005054.100,A,*05
$GPRMC,005054.100,A,1451.0161,S,17916.2855,E,14202.12,142.88,281214,,, *3F
$GPVTG,142.88,T,,M,14202.12,N,26302.38,K,A,*1E
$GPGSV,4,1,15,12,54,56,45,21,40,284,45,27,5,13,00,18,20,346,45*49
$GPGSV,4,2,15,15,8,31,45,30,8,233,00,02,6,139,00,25,72,186,45*7E
$GPGSV,4,3,15,05,29,122,45,,,,,09,12,5,45,,,,*7A
$GPGSV,4,4,15,,,,,,,*7D
$PSLSP,3065.1001232,801,-6596649.995,79478.615,-1744310.844,7,2.6*7E
$PSLSV,3065.1001232,801,1451.437,-4428.612,-5626.881,7,2.6*49
$PSLSS,3.30,1.20,3.29,45,9,22*7B
$GPGGA,005055.100,1453.9667,S,17918.5828,E,1,7,1.4,447101.6,M,0,M,,, *48
$GPGSA,M,3,12,21,18,15,25,05,09,,,,,2.6,1.4,2.1*3A
$GPGLL,1453.9667,S,17918.5828,E,005055.100,A,*0D
$GPRMC,005055.100,A,1453.9667,S,17918.5828,E,14202.14,142.86,281214,,, *3F
$GPVTG,142.86,T,,M,14202.14,N,26302.43,K,A,*1A
$GPGSV,4,1,15,12,54,56,45,21,40,284,45,27,5,13,00,18,20,346,45*49
$GPGSV,4,2,15,15,8,31,45,30,8,233,00,02,6,139,00,25,72,186,45*7E
$GPGSV,4,3,15,05,29,122,45,,,,,09,12,5,45,,,,*7A
$GPGSV,4,4,15,,,,,,,*7D
    
```

ENGINEERING MODEL

The piNAV-NG is also available in the Engineering Model grade version in order to support the Flat Sat design, as well as the onboard data output parsing software development (such as ADCS, OBC, etc.). A special care have to be taken to the EMC/EMI environment in order to maximize the receiver sensitivity yield. To test whether the satellite bus subsystems, Flat Sat or satellite Qualification Model (magnetorquers, MPPT solar controllers, DC/DC converters, transmitters, mixers, local oscillators, etc.) are not affecting the piNAV-NG system noise floor, the Engineering Model grade with identical electrical and RF properties is a perfect tool to perform an RF/EMI survey. **It is highly recommended to run the test before the flight and observe whether the fully operational satellite is not limiting the maximum available SNR values and/or functionality.**

The red **Remove Before Flight** finish reminds to replace the unit with the Flight Model grade unit suitable for the environment of space, in case it is used on Flight Model of the satellite. The firmware of the EM model is modified by the velocity limitation (500 m/s) and is also not intended for flight (not intended for vacuum use). To distinguish between FM and EM firmware, please note chapter: Output Data Description. The piNAV-NG/EM (Engineering Model) unit is depicted in Fig. 8 in both top and bottom sides with the REMOVE BEFORE FLIGHT label.

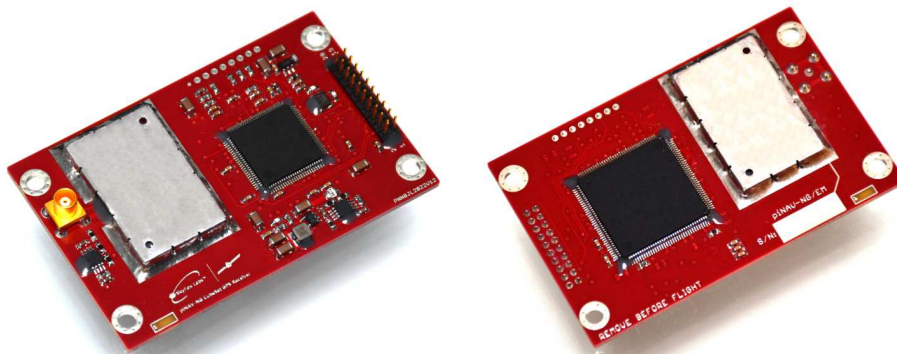

Fig. 8 Engineering Model of the piNAV-NG unit with Red Remove Before Flight finish - Top side (left), Bottom side (right).

TIMING DIAGRAM

The NMEA and piNAV sentences are available at the TXD output pin. Although the NMEA sentences order is generally not defined, the piNAV-NG receiver has been developed to provide sentences in following order: **LSP (first)**, **LSV**, **LSS**, **GGA**, **GSA**, **GLL**, **RCM**, **VTG**, **GSV1**, **GSV2**, **GSV3** and **GSV4 (last)**. With a maximum of 80 characters, the data stream is up to a maximum of 880 bytes long including CR+LF characters.

The VPP signal is derived from the receiver frequency standard and generated during whole receiver operation even if the PVT (fix) is not available. If the PVT (fix) is available, receiver calculates GPS and UTC time of the VPP raising edge and provides it in navigation sentences. The 2 sigma uncertainty of the GPS time of the raising edge does not exceed 1 μ s.

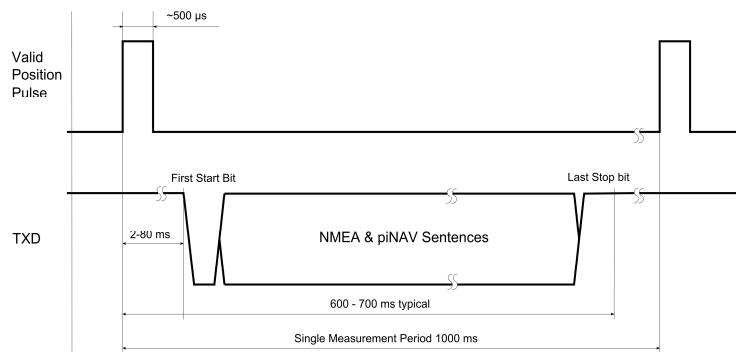

Fig. 9 The piNAV-NG VPP and TXD output signals timing diagram, single measurement period shown.

Description of signal waveforms (continuous log. 0, a 1-Hz square wave and continuous log. 1) present at the Position Fix (PF) pin is given in Tab.: 1. The signal is synchronized to the piNAV-NG measurement cycle defined in Fig. 9 (Single Measurement Period). When the VPP pulses are provided (position data available), the PF pin is kept high.

EVALUATION KIT

The piNAV-NG Evaluation Kit in Fig. 10 has been developed to support the piNAV-NG GPS receiver implementation together with the NMEA and piNAV sentences onboard parsing software development in engineering, development and breadboarding (AIV, AIT) phases.

It enables to connect and power the piNAV-NG receiver from the USB port easily. Current consumption measurement and output data waveforms can be captured by conventional Ammeter and Scope probe using current sensing and serial port pin headers. Indicating LEDs inform directly about the signal statuses. The device is not intended for spaceflight. In case the **PC/104+ Adapter Board for Spaceflight is required**, please contact the factory for more details and **PC/104+ interface characterization**.



Fig. 10 The piNAV-NG PC/104+ Form Factor Evaluation Kit PCB Unit for development purposes (not for flight).

The piNAV Evaluation Kit is available together with the Engineering Model (piNAV-NG/EM). It is also offered as a separate product for Flight Models integration activities.

APPLICATION NOTES & RECOMMENDATIONS

EMC CONSIDERATIONS

As the size of the small satellites imply the high level of integration of different electronic devices (switch mode power supplies, high speed digital electronics, pulse-width modulated electromagnetic actuators, etc.) into a limited satellite structure volume containing potential sources of disturbing signals, the electromagnetic susceptibility and compatibility is critical for implementation of any subsystems sensitive to electromagnetic radiation.

Proper ground planes and PCB design rules minimizing the radiated and conducted emissions shall be applied within the whole small satellite structure, including custom payloads, conventional (Communication and Data Handling, Power Supply and Power Distribution, Onboard Computer, Attitude Determination and Control) and third party electronic subsystems. The small satellite electronics should be properly designed to not disturb the GPS receiver input with harmonic frequencies falling to the GPS L1 frequency band.



NOTE: The C/N_0 parameter provided in GSV sentences can be exploited as a diagnosis tool if the EMC issues affect the piNAV-NG reception capability. **Always observe the C/N_0 levels and switch On/Off each electronic subsystem to identify the potential source of the disturbance if needed, using open-sky signal quality.**

ANTENNA LOCATION

Special care should be taken to the interference with the small satellite communication subsystem, as an active electronic device radiating the high power electromagnetic waves. The manufacturer recommends installing the GPS antenna as far from the (transmitting) communication antennas as possible.

Be sure to test the target small satellite subsystems against affecting the performance of the piNAV-NG receiver under all satellite operation conditions. Keep in mind the receiver may be sensitive to harmonics of the downlink (transmitter) frequency (i.e. 1575 MHz /9, /8, /7, /6, /5 /4, /3, /2, etc.) or uplink receiver spurious emissions, local MPPT EMC radiation, magnetorquer PWM EMC radiation, etc. **It is highly recommended to perform full functional test on the flight or flight-representative satellite model to ensure the EMC compatibility!!!**

The piNAV-NG receiver has been successfully tested onboard the 1U CubeSat with omnidirectional antenna and FM modulated transmitter with 1000 mW_{EIRP} output power at the UHF band (435 MHz) and 7-order Pi LC harmonic filter with no functional degradation of the receiver performance.

QUALITY ASSURANCE

GENERAL INFORMATION

Since the piNAV-NG receiver has been designed for the operation in harsh space environment as a specially featured electronic device based on Commercial Off-the-Shelf (COTS) components, the special care is taken to follow the standardized space-grade product assembly procedures, materials and components where possible (i.e. no Radiation Hardened integrated circuit are used).

MATERIALS

Components are soldered on the 6-layers FR-4 PCB, using 60/40% (Tin/Lead) compound. No PCB solder mask is used on the Flight Model units to exclude the outgassing. Instead a conformal coating is applied. Engineering Models contains red solder mask and is not intended for flight/vacuum environment. The volume of the gold is limited to a minimum by implementing the only gold-plated MCX antenna connector providing excellent RF and contacting performance and main interface connector for improved conductivity.

Vacuum-proof electronic components from ESA and NASA-preferred space-grade vendors are used (i.e. no electrolytic capacitors) in industrial or military temperature grade, where possible.

PACKAGING & SHIPPING

Once the piNAV-NG successfully passes the screening, electrical, radio and firmware test, it is finally cleaned, optically inspected and shipped encapsulated in ESD protective packaging.

EXPORT CONTROL

Since the country of origin of this product (the Czech Republic) is a valid participating member of the Wassenaar Agreement (<http://www.wassenaar.org>) and agrees with the Missile Technology Control Regime (<http://www.mtcr.info>) and the **piNAV-NG/FM, piNAV-NG/EM (Space-grade Flight Model, Engineering Model)** functional parameters are considered as a regulated (Dual Use) goods, the export is controlled and needs special Export License approved by the Ministry of Industry and Trade of the Czech Republic (the local control entity). The request for the Export License has to be submitted by the manufacturer to the local control entity, based on the binding order, including all the information as: the characteristics of goods, target country (territory), detailed end-user and target application information, etc.

DISCLAIMER

THIS DEVICE HAS BEEN DEVELOPED WITH IDEA TO SUPPORT THE SMALL SATELLITE COMMUNITY EFFORT IN SPACE RELATED RESEARCH, ENGINEERING AND PEACEFUL CONQUEST OF SPACE. THE MANUFACTURER RESERVES ALL RIGHTS TO DECLINE THE ORDER OF THIS PRODUCT OR PROVIDE ANY FURTHER INFORMATION TO END USERS ASSUMING TO VIOLATE ANY LOCAL OR GLOBAL NATIONAL LAWS BY THIS DEVICE OR INFORMATION MENTIONED IN THIS AND RELATED DOCUMENTS. MANUFACTURER DOES NOT ASSUME ANY LIABILITY ARISING OUT OF THE APPLICATION OR USE OF THIS PRODUCT OR CIRCUIT DESCRIBED HEREIN; NEITHER DOES IT CONVEY ANY LICENSE UNDER ITS PATENT RIGHTS, NOR THE RIGHTS OF OTHERS. MANUFACTURER RESERVES THE RIGHT TO MAKE CHANGES OF THIS PRODUCT DATASHEET WITHOUT FURTHER NOTICE. THE UNIT MUST NOT BE USED IN ANY SAFETY-CRITICAL APPLICATION, OR MILITARY-RELATED, OR BY ARMED FORCES, OR BY POLICE GUARDS, OR IN NUCLEAR FACILITIES, OR IN RELATION TO OIL AND GAS MINING, ON LAUNCHERS, MISSILES, TARGET DRONES, WEAPONS OF MASS DESTRUCTION, OR GOVERNMENTAL END USE OR END USER. SAFETY-CRITICAL SYSTEMS ARE THOSE SYSTEMS WHOSE FAILURE COULD RESULT IN LOSS OF LIFE, SIGNIFICANT PROPERTY DAMAGE OR DAMAGE TO THE ENVIRONMENT. THE LIST CONTAINS MOST IMPORTANT AREAS OF PROHIBITED USE AND IS NOT COMPLETE. FOR MORE DETAILS, PLEASE CONTACT FACTORY.



Prague, Czech Republic

© 2014-2024 SkyFox Labs, All rights reserved.



Your easy way to space.



Space-Friendly™

PC/104+ CubeSat Compatible piNAV-NG/Evaluation Kit

Quick Start Guide

Rev. E/2024

Intended to cover all **CubeSat Project** needs.

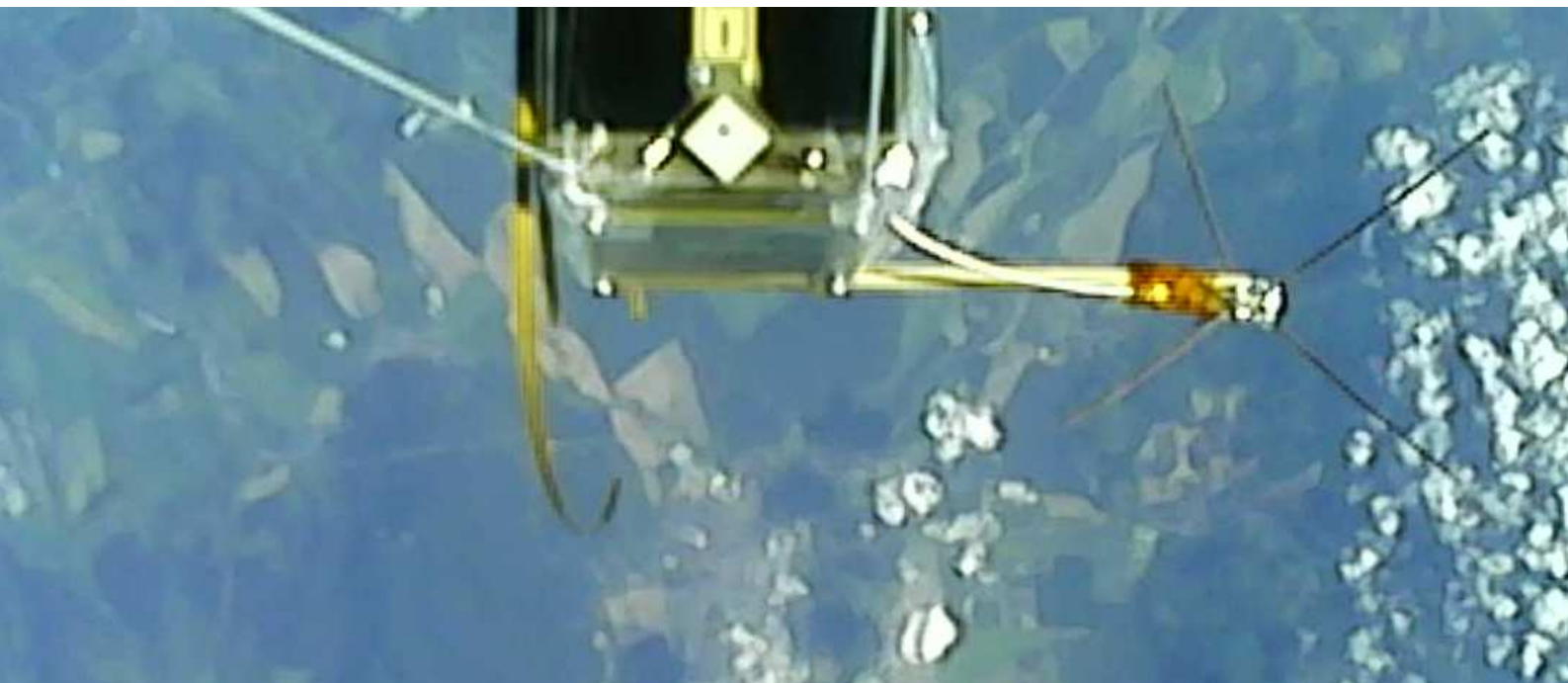

Quick Start Guide

piNAV-NG / Evaluation Kit

GENERAL DESCRIPTION

To make the first meet with the Space-Friendly™ Ultra Low Power CubeSat GPS Receiver piNAV-NG comfortable and effective, the PC/104+ Evaluation Kit has been designed and is provided with each piNAV-NG/EM (Engineering Model) and piNAV-NG/FM (Flight Model).

The Evaluation Kit package contains the main PCB with indicating LEDs, test pins to be used with scope probe hooks, low voltage linear regulator (3.3 V), current sensing pins, header for the external USB-to-TTL serial cable connector (included) and the connector for the piNAV-NG main interface. The module is powered directly from the USB port and can be operated simply from portable PC.

The Kit provides excellent opportunity to study the recommended mechanical mounting layout using footprint library (CadSoft EAGLE) as well. Four 15mm long standoffs are delivered to demonstrate the available space below or above the piNAV-NG receiver when mounted onto the Evaluation Kit PCB.

Since the current consumption of the receiver connected to the Evaluation Kit is far below typical USB current driving capability (500 mA @ 5V), the piNAV-NG interfaced to the Evaluation kit can be left running without any external power source. However, it is strongly recommended to check the current consumption especially after connecting the unknown Active (or passive) GPS antenna, as this may rise up the power consumption and could cause the damage of the USB port.

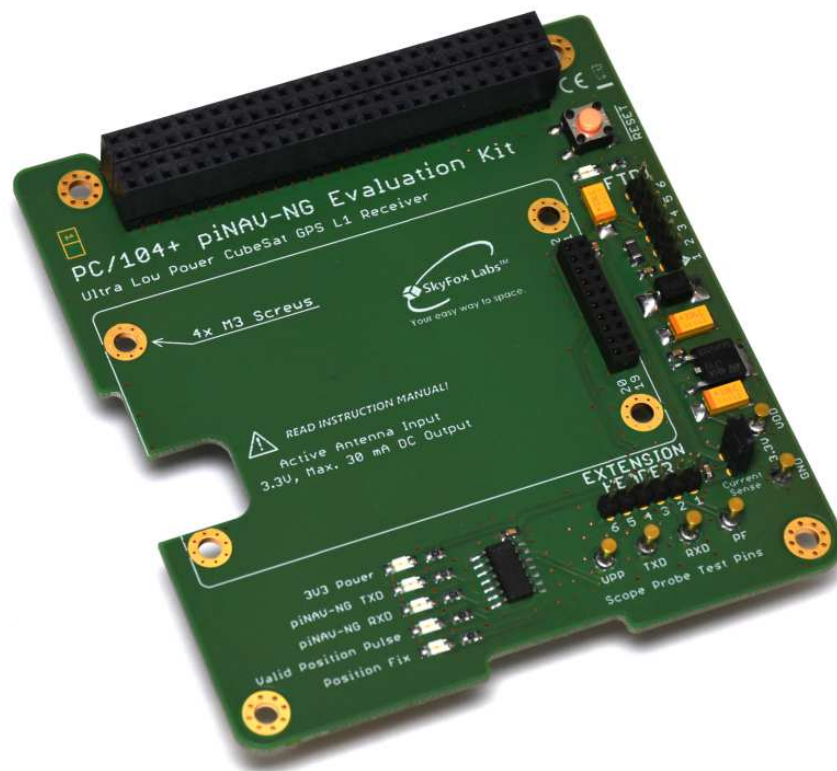

Fig. 1 The piNAV-NG / Evaluation Kit, PC/104+ CubeSat Kit Compatible. Note, piNAV-NG receiver is not a part of the Evaluation Kit.

TABLE OF CONTENTS

GENERAL DESCRIPTION.....	2	THEORY OF OPERATION.....	7
TABLE OF CONTENTS.....	3	ANTENNA.....	7
ABSOLUTE MAXIMUM RATINGS.....	3	PROTOCOLS.....	8
BOARD DESCRIPTION.....	3	APPLICATION NOTES & RECOMMENDATIONS.....	9
SCHEMATIC DIAGRAM.....	6	DISCLAIMER.....	10

ABSOLUTE MAXIMUM RATINGS

V_{DD} (TP1) to GND (TP2)	-0.3 V to (≤ 4.2 V max)	Other Pins to GND:.....	-0.3 V to $+(V_{DD} + 0.3)$ V
DC Input Voltage: V_I	-0.3 V to $V_{DD} + 0.3$ V (≤ 4.2 V max.)	Maximum Output Current to the Active Antenna:.....	100 mA
DC Output Voltage: V_O	-0.3 V to $V_{DD} + 0.3$ V (≤ 4.2 V max.)	Operating Temperature Range:.....	0°C to +70°C
DC Input Current: I_I at $V_I < 0$ V or $V_I > V_{DD}$	± 20 mA	Storage Temperature Range:.....	0°C to +70°C
DC Output Current: I_O at $V_O < 0$ V or $V_O > V_{DD}$	± 20 mA		

NOTE:

- 1) Stresses beyond those listed under “Absolute Maximum Ratings” may cause permanent damage to the device. These are stress ratings only, and functional operation of the device at these or any other conditions beyond those indicated under specification conditions is not implied. Exposure to absolute maximum rated conditions for extended periods may affect device reliability. Voltage values are with respect to system ground terminal. The manufacturer reserves all rights to decline the responsibility for any damage caused by improper using of the piNAV-NG / Evaluation Kit.
- 2) **The VDD test pin TP1 together with GND test pin TP2 are for voltage sensing purpose only! Never connect any external voltage source to these pins !!!**



CAUTION: Because the central pin of the MCX coaxial connector mounted on the piNAV-NG receiver is under DC bias when the receiver is powered on, the special care has to be taken when handling with the coaxial cable, connector and antenna as well. Never connect the GPS antenna element designed as a closed dipole antenna, closed loop antenna, closed helical type, etc. to the receiver input to prevent the short circuit of the DC bias feed. Keep in mind, the central tap of the conventional patch antenna is galvanically connected to the DC bias feed. Prevent the tap against short circuit with the ground plane or GND potential when the receiver is turned On. Always disconnect the power before start to change the receiver electrical/mechanical setup. Short circuit of the DC bias feeding or its overloading over the Absolute maximum ratings may affect device reliability, damage the device and void the product warranty.

BOARD DESCRIPTION

Two sided PCB with outer dimensions of 90.2×95.9 mm contains five indicating LEDs, test pins and connectors required to properly interface the piNAV-NG with the PC via USB.

Green LED shows the presence of 3.3V voltage at the output of the regulator. It indicates the proper powering from the USB port. It shines permanently, when the kit is powered On.

Red LED is connected to monitor the data output stream from the piNAV-NG. The LED driver is not inverting and thus the normal condition on the serial bus (the idle state, no data output) is indicated by constant shine. However, immediately after initialization of the receiver it starts to blink with respect to data stream. Since the transmitted logical zero (each start bit for example) at the TXD output pin changes the “duty cycle” of the LED power, it starts to fade. After the data packet is sent, the red LED is shining in full power again (for approx. 300 milliseconds). This cycle is repeating each second and thus the 1 Hz shining and fading can be observed in nominal operation.

Yellow LED is present to complete the bidirectional indicator of data stream. This LED is not used in nominal operation, since the piNAV-NG ignores incoming data at the RXD pin.

Two blue LEDs are used to indicate the Valid Position Pulse and Position Fix signals. Since the log. 1 of the Valid Position Pulse is very fast (~500 μ s), the VPP LED is only weakly flashing, each 1 second. The raising edge at this line indicates the time to which the position provided by the piNAV was actual. This pin can be utilized for synchronization of the other (satellite) systems to the GPS or UTC time.

The second, Position Fix LED, indicates the actual status of the piNAV-NG. Log. 0 indicates no GPS satellites are being tracked resulting in no position data provided. Pulses with 0.5 Hz frequency (1000 ms log. 1, 1000 ms log. 0) indicates tracking of at least one GPS satellite, however no position data can be provided (not enough satellites processed or visible to calculate the position). Permanent log. 1 (shining) indicates the piNAV-

NG GPS position fix and provision of navigation data. Navigation data are valid and based on at least four GPS satellites in view.

The piNAV-NG receiver is connected to the Evaluation Kit via the System Interface dual row 2x10 pin connector header (2 mm pitch). Each pin, its function and direction or manner of use is indicated in the Tab.: below. The system is powered via the FTDI USB to TTL serial cable via connector labeled as “FTDI”.

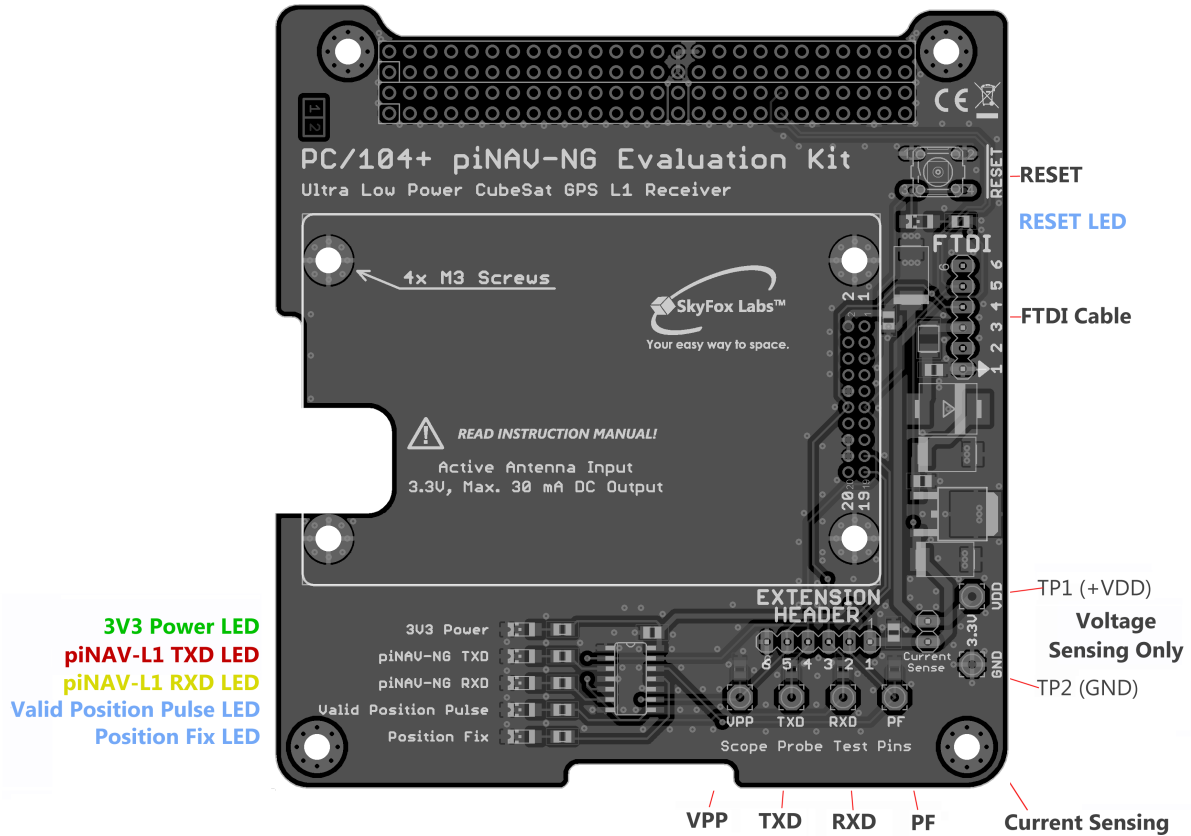

Fig. 2 Test pins, indicating LEDs and connectors of the piNAV-NG Evaluation Kit.

Tab.: 1 The piNAV-NG Pin Description, NOTE: Minimum required interface pins are highlighted.

Pin	Name	I/O, Power or Do Not Connect	Description
1	NC	DNC	Do not connect. Keep left floating. For factory purpose only.
2	VDD	Power	Positive system power input. Positive power supply input, connect to +3.3 V with respect to GND system ground pin.
3	NC	DNC	Do not connect. Keep left floating. For factory purpose only.
4	NC	DNC	Do not connect. Keep left floating. For factory purpose only.
5	/RESET	I	Reset Input. Active in log. 0. No reset pulse needed. May be used to force Cold Start.
6	NC	DNC	Do not connect. Keep left floating. For factory purpose only.
7	NC	DNC	Do not connect. Keep left floating. For factory purpose only.
8	NC	DNC	Do not connect. Keep left floating. For factory purpose only.
9	NC	DNC	Do not connect. Keep left floating. For factory purpose only.
10	GND	Power	System ground. Must be connected to ground potential. This pin is internally connected (equal) to pin 13, 16 and 18.
11	TXD	O	GPS Receiver Serial Data Output. NMEA and piNAV sentences are present on this pin. Data is provided by standard UART serial transfer at a rate of 9600 bps, no parity, 8 databits, 1 stop bit. New set of sentences are provided with update frequency of 1 Hz. LVCMOS compatible.
12	RXD	I	GPS Receiver serial data input. Not used in normal operation. Data received on this pin has no effect. For future use. LVCMOS compatible.
13	GND	Power	System ground. Must be connected to ground potential. This pin is internally connected (equal) to pin 10, 16 and 18.
14	NC	DNC	Do not connect. Keep left floating. For factory purpose only.
15	NC	DNC	Do not connect. Keep left floating. For factory purpose only.
16	GND	Power	System ground. Must be connected to ground potential. This pin is internally connected (equal) to pin 10, 13 and 18.
17	PF	O	Position Fix. This pin indicates the actual status of the piNAV-L1. Log. 0 indicates no

			GPS satellites are being tracked, no position data will be provided. Pulses with 0.5 Hz frequency (1000 ms log. 1, 1000 ms log. 0) indicates tracking of at least one GPS satellite, however no position data can be provided (not enough satellites). Permanent log. 1 indicates the piNAV-L1 GPS position fix and provision of navigation data. Navigation data are valid and based on at least four GPS satellites in view.
18	GND	Power	System ground. Must be connected to ground potential. This pin is internally connected (equal) to pin 10, 13 and 16.
19	VPP	O	Valid Position Pulse. Raising edge on this pin indicates time to which the position provided by the piNAV was actual. This pin can be utilized for synchronization of the other satellite systems to the GPS or UTC time. LVCMOS compatible.
20	NC	DNC	Do not connect. Keep left floating. For factory purpose only.

Tab.: 2 **The piNAV-NG/Evaluation Kit PC/104+ Pin Description**, NOTE: Minimum required interface pins are highlighted.

Pin	Name	I/O, Power or Do Not Connect	Description
H1.39	TXD_MHX	O	GPS Receiver Serial Data Output. NMEA and piNAV sentences are present on this pin. Data is provided by standard UART serial transfer at a rate of 9600 bps, no parity, 8 databits, 1 stop bit. New set of sentences are provided with update frequency of 1 Hz. LVCMOS compatible.
H1.40	RXD_MHX	I	GPS Receiver serial data input. Not used in normal operation. Data received on this pin has no effect. For future use. LVCMOS compatible.
H2.29	GND1	Power	System ground. This pin is internally connected (equal) to pin 10, 13, 16 and 18.
H2.30	GND2	Power	System ground. This pin is internally connected (equal) to pin 10, 13, 16 and 18.
H2.32	GND3	Power	System ground. This pin is internally connected (equal) to pin 10, 13, 16 and 18.

The piNAV-NG receiver is equipped with the female MCX straight RF connector (located on the piNAV-NG module, no antenna connector on Evaluation Kit). The male right angle MCX connector is recommended.

SCHEMATIC DIAGRAM

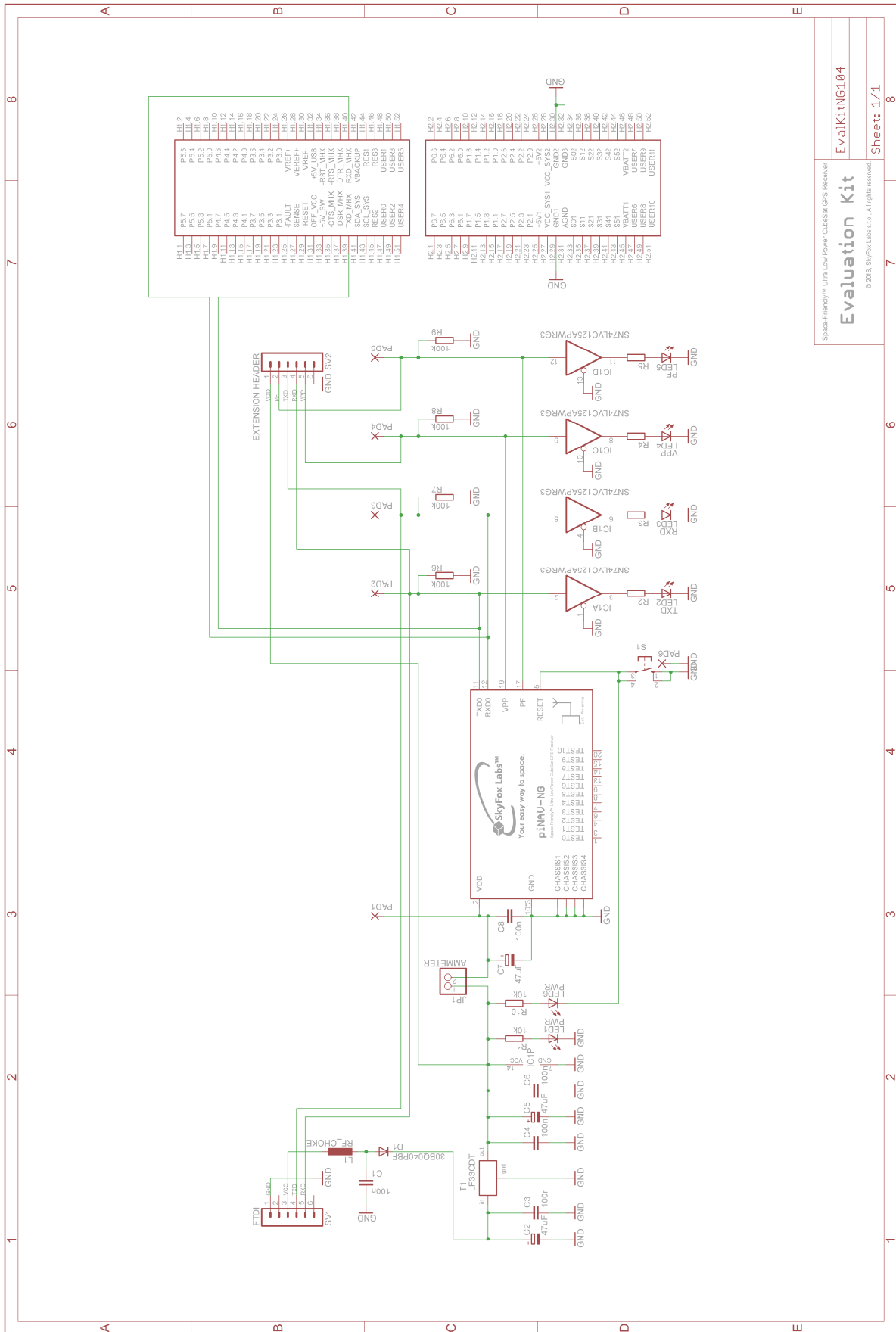

Space-Friendly™ Ultra-Low-Power-CubeSat-GPS-Receiver
Evaluation Kit
 © 2018, SkyFox Labs s.r.o., All rights reserved

EvaKitNG104

Sheet 1 / 1

THEORY OF OPERATION

The Evaluation Kit uses connection to the PC via delivered USB cable, running as a virtual com port (also known as VCP). The FTDI TTL-232R-3V3 cable with LVCMOS compatible signalling is used. Software drivers for VCP are available online at <http://www.ftdichip.com/Drivers/VCP.htm> supporting Windows, Linux, Mac OS X, Windows CE with various release versions. After successful driver installation, keep the USB cable connected and identify the newly added (virtual) COM port number installed in your system especially for the FTDI cable. Note that the VCP COM port number can vary within one PC, when the cable is connected to the PC via different USB ports. If the user software or terminal is not able to “open” the COM port, please check the proper drivers installation, installed COM port number or FTDI cable connection to the USB. Note that once opened COM port cannot be opened more times.

The communication setup have to be set to 9600 bits per second, no parity, 1 stop bit and 8 data bits. No other configuration will work properly. Use conventional serial communication terminal software to display the data provided by the piNAV-NG.

The Evaluation kit can be used to feed the dedicated microcontroller system. For such case, the 2.54 mm pitch pin header footprint is allocated for soldering of dedicated 6 pin extension interface connector header (SV2 in Fig. 3, not soldered).

Conventional ammeter can be used to determine the current consumption. For this purpose two-way header with 2.54 mm pitch is available on the Evaluation Kit. Disconnect the USB from PC first to terminate the input power. Remove the jumper (shorted current sensing) and connect the measurement device with the current rating of at least 200 mA. Then turn On the whole setup again and determine the input current. The current is measured directly before the piNAV-NG receiver at the 3.3V power source. In cooperation with voltage sensing measurement, the total input power can be calculated as $P_{IN} = I_{SENSE} \cdot V_{DD}$.

ANTENNA

The piNAV-NG receiver has been tested with various GPS antennas including passive and active (including/excluding local Low Noise Amplifier), helical, loop, GP and patch antennas to find the best setup providing maximum receiver performance, sensitivity and position fix capability onboard the CubeSat structure. The best results were observed with the patch antenna (20×20 mm) and local LNA (gain $P_{LNA} \geq +13$ dBm, noise figure NF approx. 1 dB) and Z-axis CubeSat panel serving as the Patch Antenna ground plane (copper PCB with square shape, outer dimensions 100×100 mm and milled corners fitting the standard CubeSat Structure Z-axis footprint). It is recommended to keep the antenna facing the Zenith with suitable ADCS (Attitude Determination and Control Subsystem). Recommended deviation from the Zenith allowing the piNAV-NG to fix the position within the t_{TFF} time is determined as a cone of $\pm 45^\circ$ along the Z-axis as described in Fig. 4.



NOTE: *The blocking of the satellite reception by the target satellite construction or improper orientation of the antenna deteriorates the piNAV-NG receiver performance and prolongs the Time-to-First-Fix (t_{TFF}) parameter (mentioned in the piNAV-NG Product Datasheet). The receiver disposes by sufficient tracking and acquisition margins and can be operated even if the part of the sky is blocked by the obstacle. However, the performance of the receiver cannot be guaranteed then. Note that the acquired satellite should be tracked at last 30 seconds with $C/N_0 > 35$ dBc-Hz to be able to receive ephemeris data and then the C/N_0 could not fall below 25 dBc-Hz permanently, otherwise the satellite tracking is not possible (typical Zenith GPS satellites are tracked on ground at approx. 43 to 48 dBc-Hz with passive antenna).*

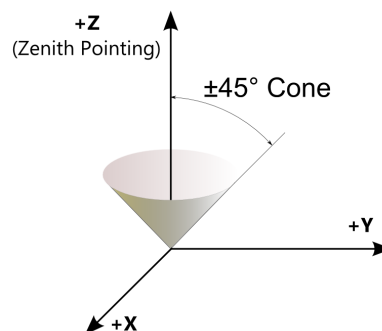

Fig. 4 The conical area borders of the vector perpendicular to recommended GPS patch antenna’s ground plane.

After the position fix the antenna can be swapped or rotated or periodically rotated in attitude to Nadir position and back to Zenith, whilst the tracking of the satellites is kept. However, when the signal to noise ratio C/N_0 of at least four visible GPS satellites fall below the 35 dB level at the RF_{IN} input of the receiver, the position calculation will not be available to avoid providing with too inaccurate position data. When the C/N_0 of the latest four satellites serving for navigation reception falls below the minimum $P_{RF_IN-Trck}$ the receiver will be trying to maintain the tracking of the satellites while actively perform the seeking for the new satellites. The total loss of all satellite signals results in no position data output. To recover the position information output the receiver need to spend the cold start time again.

The antenna quality can be analysed by the SNR parameters in GSV navigation sentences. The SNR of the satellite signal with the active antenna in the place with clear view to the whole sky shall be at least 48 dBc-Hz for Zenith GPS satellites and at least 43 dBc-Hz for satellites with elevation higher than 30° .

Special care should be taken to the installation of the GPS Patch Antenna. The antenna shall be installed on the sufficiently large ground plane. The shape of the ground plane, near objects and antenna matching affects the patch resonant frequency and radiation pattern. SkyFox Labs™ as industry's first manufacturer is ready to offer to end users the recommended and proved GPS antenna mounted, glued and combined with the +Z-axis panel as the only one compact product on the small satellite market. The photo of the whole set of the GPS Active Patch Antenna with LNA is displayed in Fig. 5. For more details please see manufacturer's website at <http://www.skyfoxlabs.com>.

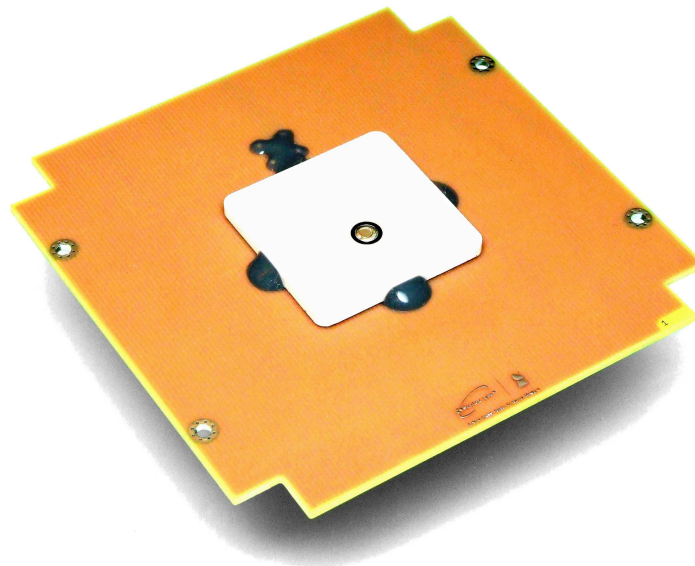

Fig. 5 The GPS Patch Antenna – Flight Model.

PROTOCOLS

The physical communication is realized via the standard UART data interface. The baud rate is set to 9600 bps, no parity, 8 data bits, 1 stop bit. Logical levels are equal to LVCMOS levels as defined in JEDEC JESD8C.01 standard.

The piNAV-NG receiver provides navigation data in standard NMEA 0183 format. The standard NMEA sentences GGA, GSA, GLL, RCM, VTG and GSV were augmented by the manufacturers's defined sentences (piNAV) LSP and LSV in the NMEA format. It provides position and velocity vector in the Cartesian coordinates in the reference frame WGS-84 and GPS time instead of UTC.

As the receiver does not store the navigation data in the non-volatile memory, the UTC time in NMEA sentences is available after reception of the ionospheric and UTC data from the satellites. The coarse GPS time in piNAV sentences is available immediately after reception of any sub-frame. The receiver time is corrected immediately after the position fix. The piNAV-NG provides position information immediately after it is calculated. For more info please refer to the piNAV-NG Product Datasheet.

APPLICATION NOTES & RECOMMENDATIONS

EMC CONSIDERATIONS

As the size of the small satellites imply the high level of integration of different electronic devices (switch mode power supplies, high speed digital electronics, pulse-width modulated electromagnetic actuators, etc.) into a limited satellite structure volume containing potential sources of disturbing signals, the electromagnetic susceptibility and compatibility is critical for implementation of any subsystems sensitive to electromagnetic radiation.

Proper ground planes and PCB design rules minimizing the radiated and conducted emissions shall be applied within the whole small satellite structure, including custom payloads, conventional (Communication and Data Handling, Power Supply and Power Distribution, Onboard Computer, Attitude Determination and Control) and third party electronic subsystems. The small satellite electronics should be properly designed to not disturb the GPS receiver input with harmonic frequencies falling to the GPS L1 frequency band.

The C/N_0 parameter provided in GSV sentences can be exploited as a diagnosis tool if the EMC issues affect the piNAV-NG reception capability. Observe the C/N_0 levels and switch On/Off each electronic subsystem to identify the potential source of the disturbance, if needed.

ANTENNA LOCATION

Special care should be taken to the interference with the small satellite communication subsystem, as an active electronic device radiating the high power electromagnetic waves. The manufacturer recommends installing the GPS antenna as far from the (transmitting) communication antennas as possible.

Be sure to test the target small satellite subsystems against affecting the performance of the piNAV-NG receiver under all satellite operation conditions. Keep in mind the receiver may be sensitive to harmonics of the downlink (transmitter) frequency (i.e. 1575 MHz /9, /8, /7, /6, /5 /4, /3, /2, etc.).

The piNAV-NG receiver has been successfully tested onboard the 1U CubeSat with omnidirectional antenna and FM modulated transmitter with 500 mW_{EIRP} output power at the UHF band (435 MHz) with no functional degradation of the receiver performance.

RECYCLING

Below mentioned logo given on the goods, its packaging or inside the user guide or other related documentation means that used electrical or electronic devices, or products should not be disposed with household waste. To ensure proper disposal of the product hand it to designated collection points, where they will be accepted free of charge. Eco disposal of our products is maintained by collective system RETELA. Please recycle product packaging in proper way. The piNAV-NG/ Evaluation Kit is RoHS Compliant.



PRODUCT SAFETY

According to use of the product in line with this Quick Start Guide, the product is safe under normal use. The CE mark (Conformité Européenne) has been issued on this family of products. Related EC Declaration of Conformity is issued with each supply and is available online at manufacturer's website <http://www.skyfoxlabs.com>.



DISCLAIMER

THIS DEVICE HAS BEEN DEVELOPED WITH IDEA TO SUPPORT THE SMALL SATELLITE COMMUNITY EFFORT IN SPACE RELATED RESEARCH, ENGINEERING AND PEACEFUL CONQUEST OF SPACE. THE MANUFACTURER RESERVES ALL RIGHTS TO DECLINE THE ORDER OF THIS PRODUCT OR PROVIDE ANY FURTHER INFORMATION TO END USERS ASSUMING TO VIOLATE ANY LOCAL OR GLOBAL NATIONAL LAWS BY THIS DEVICE OR INFORMATION MENTIONED IN THIS AND RELATED DOCUMENTS. MANUFACTURER DOES NOT ASSUME ANY LIABILITY ARISING OUT OF THE APPLICATION OR USE OF THIS PRODUCT OR CIRCUIT DESCRIBED HEREIN; NEITHER DOES IT CONVEY ANY LICENSE UNDER ITS PATENT RIGHTS, NOR THE RIGHTS OF OTHERS. MANUFACTURER RESERVES THE RIGHT TO MAKE CHANGES OF THIS PRODUCT DATASHEET WITHOUT FURTHER NOTICE. THE UNIT MUST NOT BE USED IN ANY SAFETY-CRITICAL APPLICATION, OR MILITARY-RELATED, OR BY ARMED FORCES, OR BY POLICE GUARDS, OR IN NUCLEAR FACILITIES, OR IN RELATION TO OIL AND GAS MINING, ON LAUNCHERS, MISSILES, TARGET DRONES, WEAPONS OF MASS DESTRUCTION, OR GOVERNMENTAL END USE OR END USER. SAFETY-CRITICAL SYSTEMS ARE THOSE SYSTEMS WHOSE FAILURE COULD RESULT IN LOSS OF LIFE, SIGNIFICANT PROPERTY DAMAGE OR DAMAGE TO THE ENVIRONMENT. THE LIST CONTAINS MOST IMPORTANT AREAS OF PROHIBITED USE AND IS NOT COMPLETE. FOR MORE DETAILS, PLEASE CONTACT FACTORY.



Prague, Czech Republic

© 2014-2024 SkyFox Labs, All rights reserved.